

Instructions manual  
Manuel d'instructions  
Gebrauchsanleitung  
Manuale d'uso  
Manual de instrucciones  
Manual de instruções

[MANUY1N.0B0]

ed.0

**INDEX**

INDEX .....	3
INTRODUCTION .....	5
<i>CARE OF THE MANUAL</i> .....	5
CONDITIONS OF WARRANTY .....	6
GENERAL INFORMATION .....	7
END-OF-LIFE .....	8
<i>BATTERY DISPOSAL</i> .....	8
SAFETY RULES .....	9
<i>REFRIGERANT AND LUBRICANT - PERSONAL PROTECTIVE EQUIPMENT AND PRECAUTIONS</i> .....	10
<i>HOSES CONNECTION</i> .....	10
<i>PRECAUTIONS FOR HANDLING AND USE OF R134a FLUIDS</i> .....	11
<i>RULES FOR WORKING WITH R1234yf FLUIDS</i> .....	11
PRINCIPLES OF OPERATION .....	13
SETUP .....	14
<i>R134A ACCESSORIES KIT CONTENTS</i> .....	14
<i>R1234YF ACCESSORIES KIT CONTENTS</i> .....	14
<i>R134a HOSES MOUNTING</i> .....	15
<i>R1234yf ADAPTERS AND HOSES MOUNTING</i> .....	15
<i>RELEASE REFRIGERANT SCALE</i> .....	16
<i>LOCK REFRIGERANT SCALE</i> .....	16
THE MACHINE .....	17
<i>PLASTIC COVER</i> .....	17
<i>CONTROL PANEL</i> .....	17
<i>DISPLAY ICONS</i> .....	19
<i>BASIC COMPONENTS</i> .....	20
<i>ALARMS</i> .....	27
<i>ERROR CODES</i> .....	28
PRELIMINARY OPERATIONS .....	29
QUICKSETUP .....	30
AUTOMATIC PROCEDURE .....	31
EDIT VACUUM DATA: .....	31
NOTE: use the VACUUM SETTING to change the duration of the LEAK CHECK. .....	31
EDIT OIL DATA: .....	32
EDIT GAS FILLING DATA: .....	32
START AUTOMATIC PROCEDURE: .....	34
MANUAL PROCEDURE .....	39
<i>RECOVERY</i> .....	39
<i>VACUUM</i> .....	41
<i>OIL INJECTION</i> .....	44

---

START PROCEDURE	46
<i>CHARGE</i> .....	49
START PROCEDURE	50
<b>SETUP</b> .....	53
OPTIONS	54
GAS ANALYZER <sup>(optional)</sup>	54
DATABASE SETTING	55
SETUP HEADER PRINT	55
INSERT OPERATOR NUMBER	56
SET DATE / TIME	56
LANGUAGE	57
MEASURE UNITS	57
<b>MAINTENANCE</b> .....	58
TANK FILLING	58
<i>AIR PURGE MANUAL</i> .....	60
EMPTYING HOSES	61
CHANGE DRYER FILTER	62
VACUUM PUMP	65
M.1) OIL TOP-UP	65
M.2) OIL CHANGE	67
<b>A/C PRESSURES CHECK</b> .....	70
<i>STATIC DIAGNOSIS</i> .....	73
<i>MAINTENANCE REPORT</i> .....	74
SERVICES ARCHIVE	74
SEARCH BY PLATE	75
SEARCH BY DATE	76
EXTRACT ARCHIVE	76
<i>COUNTERS</i> .....	77
<b>FILLING THE RECHARGEABLE NEW OIL CONTAINER</b> .....	78
<b>REPLACE THE NEW OIL CARTRIDGE</b> .....	79
<i>EMPTYING THE USED OIL CONTAINER</i> .....	79
<i>REPLACING THE PRINTER PAPER</i> .....	80
<b>DATA</b> .....	81
<b>CODES SUMMARY</b> .....	82

## INTRODUCTION

This machine is a pressure unit as can be seen in the CE declaration of conformity and Data plate. The equipment supplied conforms to the Essential Safety Requirements according to Annex I of Directive 2014/68/UE (PED). Any work involving repairs, modifications, and/or changing pressurized components or parts make safe use of the equipment very risky. Any tasks done must be authorized by the Manufacturer.



This manual contains important information pertinent to operator safety. Read this manual through before beginning operation of the machine.

The manufacturer reserves the right to modify this manual and the machine itself with no prior notice. We therefore recommend checking any updates. This manual must accompany the machine in case of sale or other transfer.

Any repair, modification, or changing of components not formally agreed with and authorized by the manufacturer poses a risk of the conformity to Directive 2014/68/UE being nullified and makes this pressure equipment a significant risk. If not authorized in writing the Manufacturer considers the tasks indicated above to be tampering with the machine, which nullifies the initial declaration of conformity issued, and so they do not accept any direct responsibility.

Braze welding of parts that contribute to the pressure strength of the equipment and the parts directed attached to it was done by adequately qualified personnel, using adequate operating methods. Approval of the operating methods and personnel was entrusted to a competent outside party for category III pressure equipment, and any work on this equipment that involves the need to carry out braze welding must comply with the requirements laid down in annex 1 of Directive 2014/68/UE, or the Manufacturer must be contacted for the relevant information.

- The pressure equipment has been inspected and tested, complete with the safety accessories identified by the manufacturer as being of a direct discharge type with calibrated air pressure. Testing and inspection of the accessories is not necessary prior to starting up.
- The pressure equipment must be subjected to routine inspections and checks when operating, according to the relevant regulations and legal norms.

For the unit in question, it is hereby declared that a competent Authorized Body carried out their part of the final check according to annex I of point 3.2.3 of Directive 2014/68/UE as well as checking safety accessories and control devices in conformity to comma d) of art 5 of Ministerial Decree 329 of 01/12/2004.

### List of the critical components in terms of PED safety DIR 2014/68/UE

Condenser, dehydrator filters, distributor, refrigerant storage bottle, airtight compressor, safety pressure switch, pressure transducers, and safety valves.

The operator has to check/substitute the PED critical components before their respective end of life (according to national law)

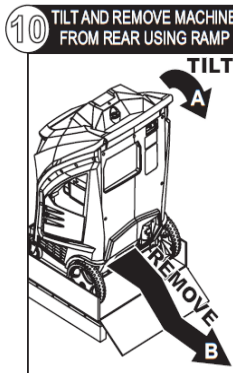
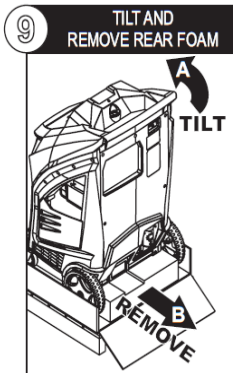
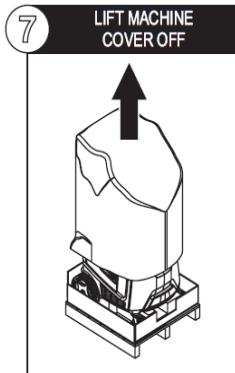
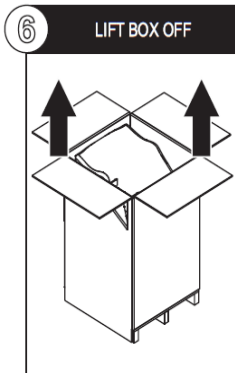
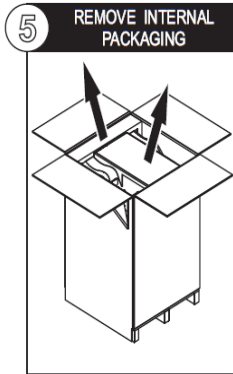
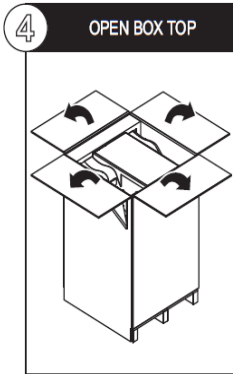
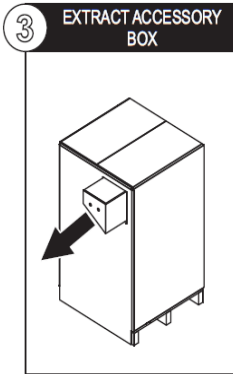
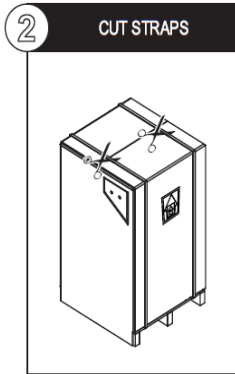
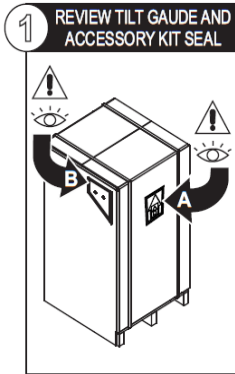
## CARE OF THE MANUAL

This manual must be kept for the entire life of the machine and protected against humidity and excessive heat. Take care not to damage this manual in any way during consultation.

# CONDITIONS OF WARRANTY

Refer to CONDITIONS OF WARRANTY booklet supplied with the machine.

## UNPACKING INSTRUCTIONS

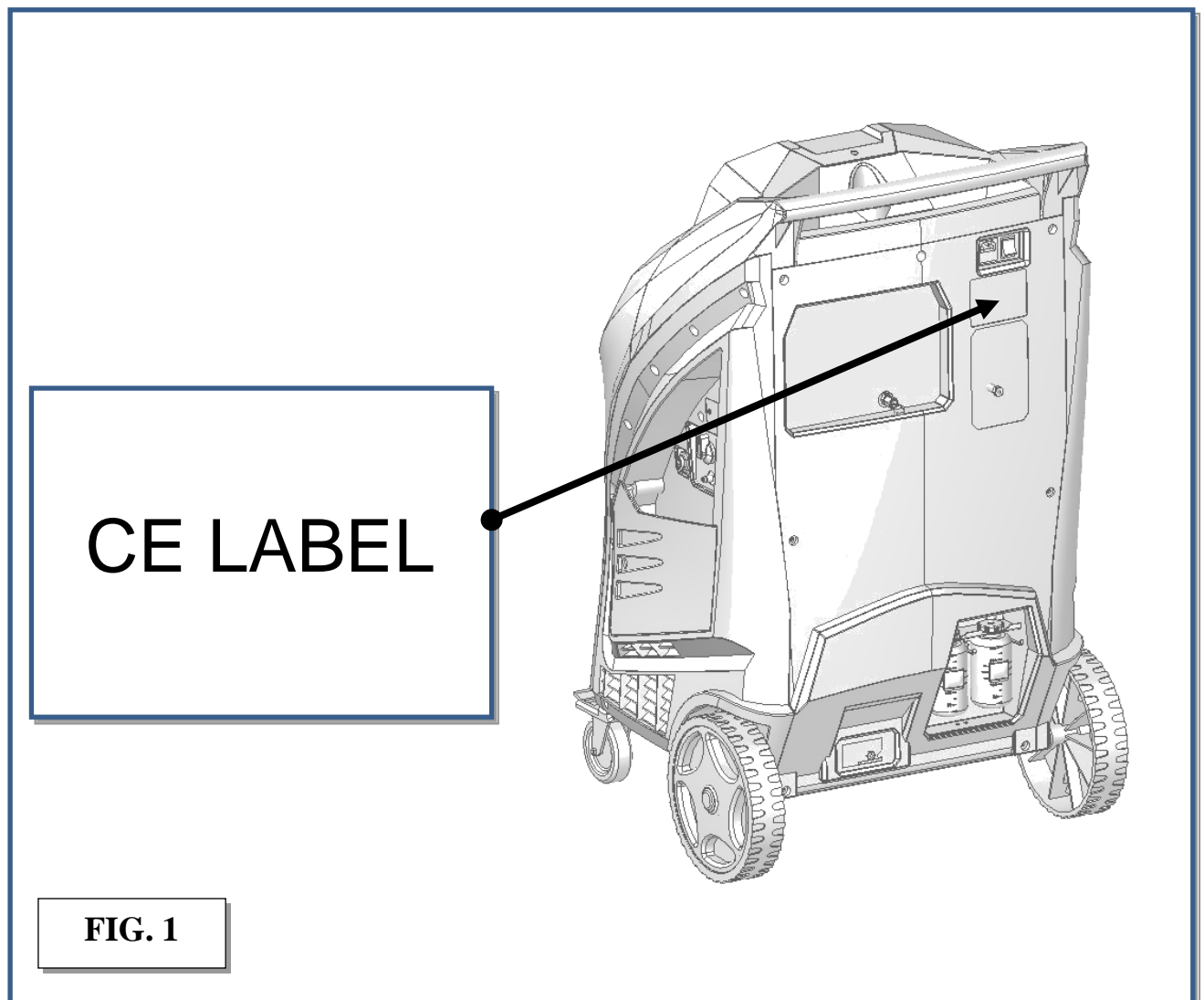


## GENERAL INFORMATION

Machine model information are printed on the data plate (see Fig.1). Overall machine dimensions:

Height:	1080 mm	Width:	660 mm
Depth:	690 mm	Weight:	63 kg
Operating temperature	10/50°C	Storage temperature	-25/+50°C

Like any equipment with moving parts, the machine inevitably produces noise. The construction system, paneling, and special provisions adopted by the Manufacturer are such that during work the average noise level of the machine is not in excess of 64 dB (A).



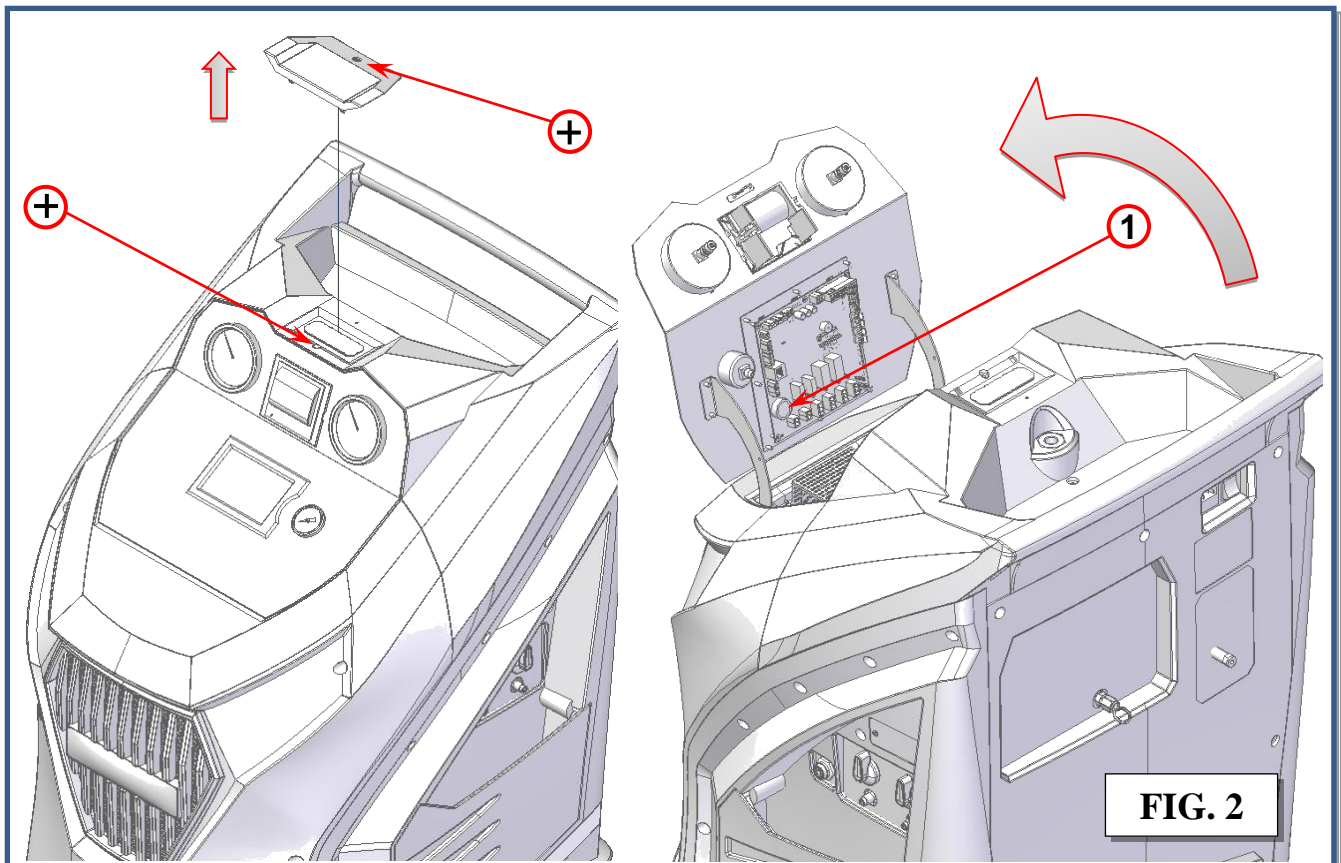
## END-OF-LIFE

The symbol on the right indicates that in accordance with Directive 2012/19/UE the machine may not be disposed of as ordinary municipal waste but must be delivered to a specialized center for separation and disposal of WEEE (Waste Electrical and Electronic Equipment) or be returned to the dealer in case of purchase of a new machine. Current legislation provides severe sanctions in the case of disposal of WEEE into the environment. If improperly used or disposed of into the environment, electrical and electronic equipment can release substances dangerous for the environment and for human health.



## BATTERY DISPOSAL

The machine uses an electronics card containing a Lithium battery (ref:1, Fig.2). When discharged, it must be removed by expert personnel trained in machine demolition.



## SAFETY RULES

This machine is a piece of equipment designed to recover R134a or R1234yf (depending on machine model) from air conditioning systems (A/C) for vehicles. The machine must be used by qualified personnel and can only be used correctly after having read this manual that also contains the basic safety rules listed below:

- **Wear gloves and safety glasses.**
- Do not expose to direct sunlight and rain.
- Before doing any task check the vehicle's operating and maintenance handbook to determine the type of refrigeration fluid used in the A/C system.
- No smoking in the vicinity of the machine and while working.

The ambient conditions for using the equipment are as follows:

- Temperature between +10 and +50°C.
- Pressure between 80 kPa (0,8 bar) and 110 kPa (1.1 bar).
- Air with normal oxygen content, generally 21% by volume.

Laying-up the machine: when not in use the machine must be stored in a specific place with the following characteristics:

1. The machine must be stored in a ventilated zone also during storage. It can be avoided that are pit near the machine.
  2. There must be no sources of ignition such as heat sources, naked flames, sparks of mechanical origin (e.g. due to grinding), electrical material (especially the storage area for the machine is not to have any electrical power sockets that are less than 900 mm above floor level), stray electrical currents and cathode corrosion (check that the electrical distribution system conforms to the relevant legal provisions), static electricity (check the earth system for the premises' electricity distribution system), and lightning.
- Hose must be visually checked periodically, if they are damaged, or aged, substitute them.
  - Use the machine away from heat sources, naked flames and/or sparks.
  - Always make sure that when you switch off the engine the vehicle's ignition key is turned to the Fully Off position.
  - Always connect the machine's piping using the RED rapid coupling to the high pressure branch of the A/C system.
  - Always connect the machine's piping using the BLUE rapid coupling to the low pressure branch of the A/C system.



**CAUTION:** some car manufacturer on the fuel intake manifold install a connector identical to the A/C low pressure fitting.

**DANGER:** DO NOT connect the recovery station to this connection; you risk to recover petrol.

- Keep the connection pipes away from moving or rotating items or elements (cooling fan, alternator, etc.).
- Keep the connection pipes away from hot items or elements (engine exhaust pipes, radiator, etc.).
- Always fill the A/C system with the quantity of fluid recommended by the manufacturer. Never exceed this quantity.
- Always check the oil levels prior to each operation.
- Always keep the oil at the correct quantity.
- Before connecting the machine to the electrical system, check that the power supply voltage and frequency are the same as the values indicated on the CE plate.

**The bottle must be filled to 80% of its maximum capacity to leave a plenum chamber for the gas to absorb any increases in pressure.**



- Never touch the taps on the inner bottle.
- Throw the oil taken out of the A/C system and the vacuum pump into the relevant containers for spent oils.
- Change the filters at the intervals laid down, using only filters recommended by the manufacturer.
- Only use the oils recommended by the manufacturer.
- Only use the UV approved by the manufacturer.
- Never confuse the vacuum pump oil with the oil for the air-conditioning systems.

Failure to comply with any of these safety rules leads to any form of guarantee for the machine being rendered null and void.

Machine is provided with class III safety valve, in case of malfunctioning it can create an external sack of flammable gas; keep the machine in well ventilated area.

**WARNING:** R134a and/or R1234yf vapor/gas refrigerant are heavier than air and may thicken on the floor or inside the cavity/pits and cause choking by reducing oxygen available for breathing.

At high temperatures the refrigerant decomposes releasing toxic and caustic substances, hazardous for the operator and the environment. Avoid inhalation of the refrigerants and A/C system oils.

Exposure can irritate the eyes and airways.

**WARNING:** The machine must be connected to a socket with effective ground

**WARNING:** This is a class “A” product. In a domestic environment this product may cause radio interference. In such cases, the user may be required to take adequate measures.

## REFRIGERANT AND LUBRICANT - PERSONAL PROTECTIVE EQUIPMENT AND PRECAUTIONS

Handled with caution refrigerants and pressure vessels, since otherwise there could be health risks.

The operator must wear safety glasses, gloves and suitable clothing to work, contact with refrigerant may cause blindness (eyes), and other physical damage (frostbite) to the operator. Avoid contact with the skin, the low boiling temperature (about -26°C for R134a and about -30°C for R1234yf ) can cause cold burns.

Do not change the setting of the relevant devices for safety, do not remove the seals of the safety valves and control systems. Do not use external tanks or other storage containers that are not approved, or without safety valves.



During the functioning, the air vents and ventilation equipment must not be blocked or covered



## HOSES CONNECTION

Hoses may contain refrigerant under pressure. Before substitute the quick coupler verify the corresponding pressure in the service hoses (gauge).

The machine is equipped with the following safety devices:

	<p><b>SAFETY PRESSURE:</b> stops the compressor in case of excessive pressure</p> <p><b>SAFETY VALVE:</b> opens when the pressure inside the system reaches a level of pressure above the estimated limits.</p> <p><b>MAIN SWITCH:</b> allows the machine’s turnoff by sectioning of the power line. Prescribing however disconnection from the mains plug of the power cord before servicing</p>
	<p><b>IT IS NOT ALLOWED ANY KIND OF TAMPERING OF THE SAFETY DEVICES MENTIONED ABOVE</b></p>

## PRECAUTIONS FOR HANDLING AND USE OF R134a FLUIDS

Refrigerant fluids expand to the gaseous state in standard environmental conditions. In order that they may be shipped and used they must be compressed into suitable bottles. We therefore recommend observing all the general precautions applicable to handling of pressurized containers. In the case of R134a in particular, we suggest the following special precautions. Avoid inhaling highly concentrated vapors even for short periods of time, since such vapors can cause loss of consciousness or death. R134a is not flammable, but if the vapor is exposed to open flames or incandescent surfaces it may undergo thermal decomposition and form acid substances. The acrid and pungent odor of these products of decomposition is sufficient to signal their presence. We therefore recommend avoiding use of R134a near open flames and incandescent elements. There exists no evidence of risks deriving from transdermal absorption of R134a. Nevertheless, due to the low boiling point of the liquid, it is advisable to wear protective garments such as to ensure that no jets of liquid or gas can come into contact with the skin. The use of goggles to avoid contact with the eyes is especially recommended, since the refrigerant liquid or gas can cause freezing of the ocular fluids. Moreover, we strongly advise users to avoid dispersing the R134a refrigerant fluid utilized in the machine since it is a substance that contributes to raising the temperature of the planet, with a global warming potential(GWP) of 1300.

## RULES FOR WORKING WITH R1234yf FLUIDS

Under ambient conditions refrigerant fluids are gases. In order to be able to transport and use them they must be compressed in specific bottles. The precautions for pressure vessels must therefore be applied.

In particular, for R1234yf be careful of the following situations:

- Inhalation of vapours at very high concentrations, even for short periods of time, must be avoided as it can cause unconsciousness and sudden death.
- R1234yf is flammable and if the vapour is exposed to naked flames or red hot surfaces it can undergo thermal decomposition with the formation of acid products. The acrid, pungent odour of these products of decomposition is sufficient to warn of their presence. Avoid finding yourself in the conditions just mentioned.
- There is no proof of risks resulting from the absorption of R1234yf through the skin, however, due to its low boiling point it is advisable to wear protective clothing that can prevent any liquid sprayed or vapour reaching the skin and especially the eyes, where they could cause the eye fluids to congeal.
- We also recommend no dispersing the R1234yf refrigerant fluid used in the machine, because it is a substance that contributes to heating the planet, with a global warming potential (GWP) of 4.

ANY USE THAT DIFFERS FROM THAT JUST DESCRIBED IS NOT ALLOWED BY THE MANUFACTURER.

### Uses not allowed

This machine may not be used for tasks not envisaged or to handle products other than those envisaged, or for uses other than those specified in paragraphs "Conditions of use envisaged".

### The following are forbidden:

1. Using the machine with a constructive configuration that differs from that envisaged by the manufacturer.

2. Using the machine in places at risk of explosion and/or fire
3. Adding other systems and/or equipment not considered by the manufacturer in their working design.
4. Using the machine without the perimeter protection and/or the fixed and mobile guards tampered with or removed.
5. Connecting the machine to energy sources other than those envisaged by the manufacturer.
6. Using the commercial devices for a purpose other than that envisaged by the manufacturer.

### **Actions not allowed on the part of the operator**

**The operator** tasked with operating, supervising, and maintaining the machine **must not:**

1. Use the machine if they have not been trained and informed beforehand as called for by the law on safety in the workplace
2. Fail to act as described in the operating instructions.
3. Allow unauthorized people to approach and/or use the machine.
4. Tamper with the moving and fixed guards that provide perimeter protection, thereby also exposing other operators and people to risks of a residual nature.
5. Remove or alter the safety signs (such as pictograms, warning signs, and others) on the machine.
6. Use the machine without having first read and understood the behavioral, operating and maintenance information contained in the operating instructions.
7. Leave the maneuvering keys on the electromechanical controls (selectors), pneumatic controls, and doors of the housings for electrical and electronic materials (electrical panels and derivation boxes).
8. Carry out the following operations as they pose residual risks:
  - Adjust the mechanical, pneumatic, or electrical parts on the machine while it is working.
  - Remove the mechanical, pneumatic, or electrical parts on the machine while it is working.
  - Remove the protective devices for mechanical, pneumatic, or electrical parts on the machine while it is working.
  - Allow the machine to run when the electrical panels are open.

These uses, that cannot be avoided by way of construction, must not be allowed.



#### **WARNING**

The employer (or safety manager) is obliged to see to it that the machine is not used in an improper manner, putting the health of the operator and people exposed first.

The operator is obliged to inform their employer (or the system safety manager) if there is a danger of improper use of the machine since, as an instructed person, the operator is responsible for the use that is to be made of the machine.

9. If service station fall down, or is hit, or in case of big leakage, or sounds of flowing gas:
  - an internal damage could happen, also if externally the machine seems good, and it is still working;
  - the machine must be taken outdoor or in a very ventilated place.
  - No fire, no smoke, no workers, no cars nearby this service station.
  - The service station must be fully tested by a trained technician before to be used again.
10. Use only the supplied power cord

## PRINCIPLES OF OPERATION

In a single series of operations, the machine permits recovering and recycling refrigerant fluids (R134a or R1234yf, depending on machine model) with no risk of releasing the fluids into the environment, and also permits purging the A/C system of humidity and deposits contained in the oil.

The machine is in fact equipped with a built-in evaporator/separator that removes oil and other impurities from the refrigerant fluid recovered from the A/C system and collects them in a container for that purpose.

The fluid is then filtered and returned perfectly recycled to the bottle installed on the machine.

The machine also permits running certain operational and seal tests on the A/C system.

## **SETUP**

The machine is supplied fully assembled and tested.

The machine is without a gas identity (R134a / R1234yf)

Choosing the appropriate kit, the machine works with the R134a or R1234yf gas.

## **R134A ACCESSORIES KIT CONTENTS**

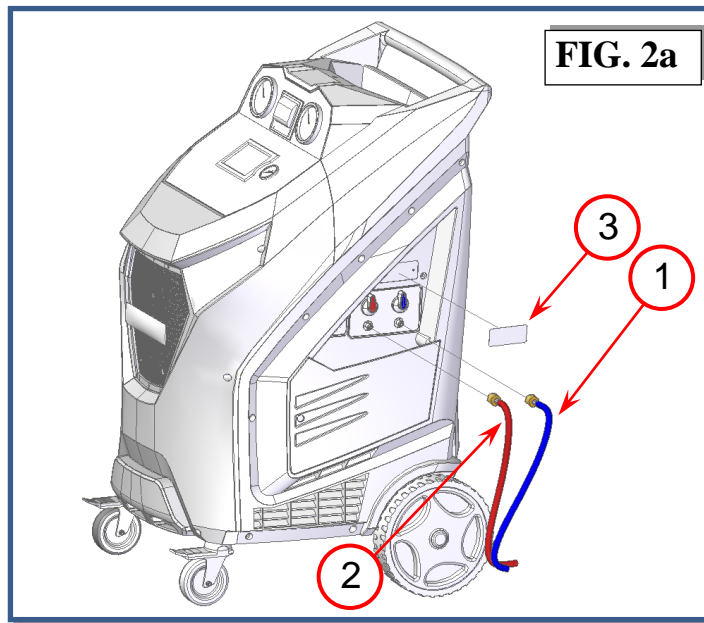
N°1 Power Cord  
N°1 R134a hose HP red  
N°1 R134a hose LP blue  
N°1 Quick coupler HP red R134a  
N°1 Quick coupler LP blue R134a  
N°1 R134a Tank fitting  
N°1 Quick coupler  
N° 1 Rechargeable new oil container (empty)  
N° R134a Gas identification plate

## **R1234YF ACCESSORIES KIT CONTENTS**

N°1 Power Cord  
N°1 R1234yf hose bypass HP red  
N°1 R1234yf hose bypass LP blue  
N°1 R1234yf hose HP red  
N°1 R1234yf hose LP blue  
N°1 Quick coupler HP red R1234yf  
N°1 Quick coupler LP blue R1234yf  
N°1 R1234yf Tank fitting  
N° 2 Quick coupler  
N° 1 Rechargeable new oil container (empty)  
N° R1234yf Gas identification plate

## R134a HOSES MOUNTING

Referring to Figure 2a, mount the hose (ref.1 Fig 2a) with the BLUE quick-connect coupling on the male threaded connector indicated by the BLUE LOW PRESSURE symbol and the RED (ref.2 Fig 2a) quick-connect coupling on the male threaded connector indicated by the RED HIGH PRESSURE symbol. Mount the self-adhesive gas identity plate (ref.3 Fig 2a)

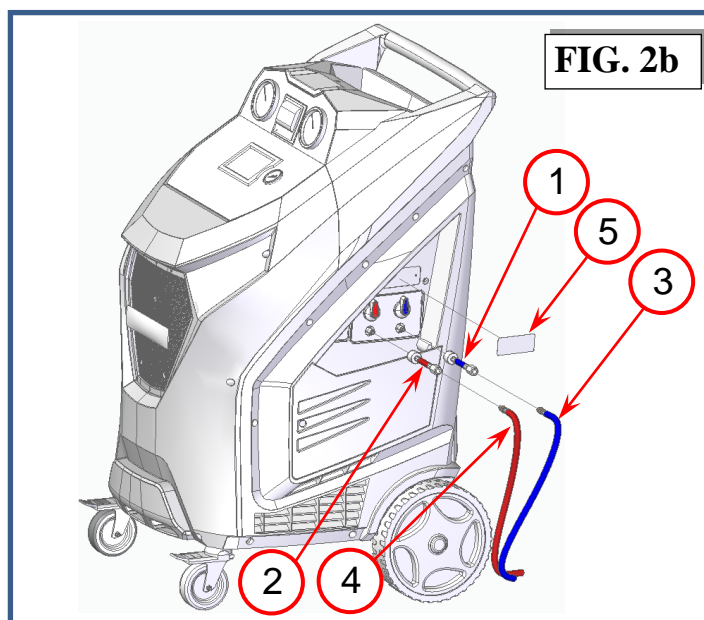


## R1234yf ADAPTERS AND HOSES MOUNTING

Referring to Figure 2b, mount the adapter (ref.1 Fig 2b) on the male threaded connector indicated by the BLUE LOW PRESSURE symbol and the RED (ref.2 Fig 2b) adapter on the male threaded connector indicated by the RED HIGH PRESSURE symbol.

Mount the hose (ref.3 Fig 2b) with the BLUE quick-connect coupling on the adapter female threaded connector and the RED (ref.4 Fig 2b) quick-connect coupling on the adapter female threaded connector.

Mount the self-adhesive gas identity plate (ref.5 Fig 2b)



## RELEASE REFRIGERANT SCALE

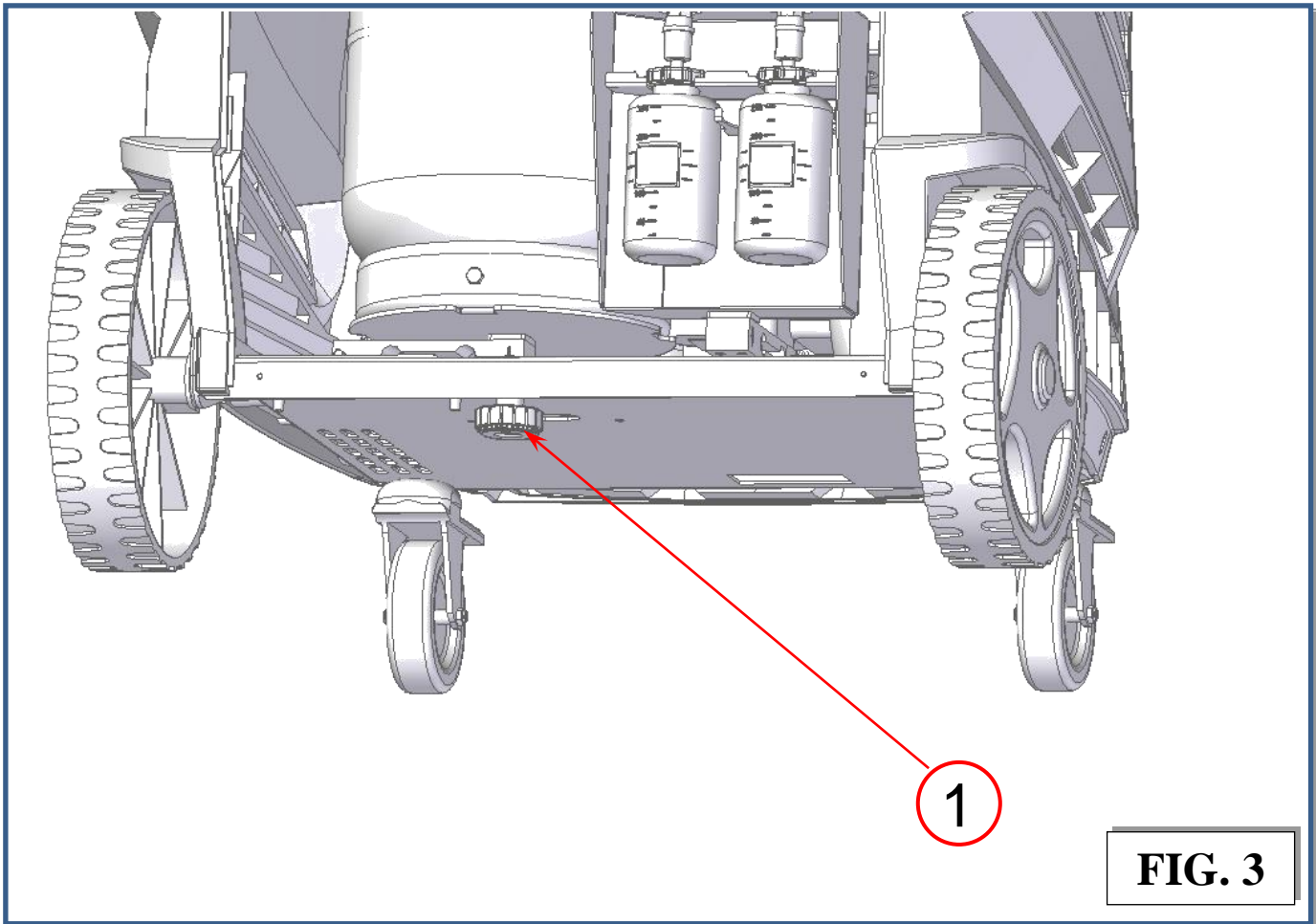
1. In order to remove the protections under the refrigerant scale the knob (ref.1, Fig.3) has to be unscrewed, removed and stored in a safe place.
2. Connect the machine to the electrical supply and switch it on
3. Check if the value of refrigerant scale is correct.

## LOCK REFRIGERANT SCALE

**NOTE:** in the event that the equipment has to be transported, the refrigerant bottle scale should be locked in place as follows:

1. Switch the machine on.
2. Tighten the knob (ref.1, Fig.3) until the display signals ZERO availability.

**NOTE:** Check that the oil containers are properly placed in their housing



**FIG. 3**

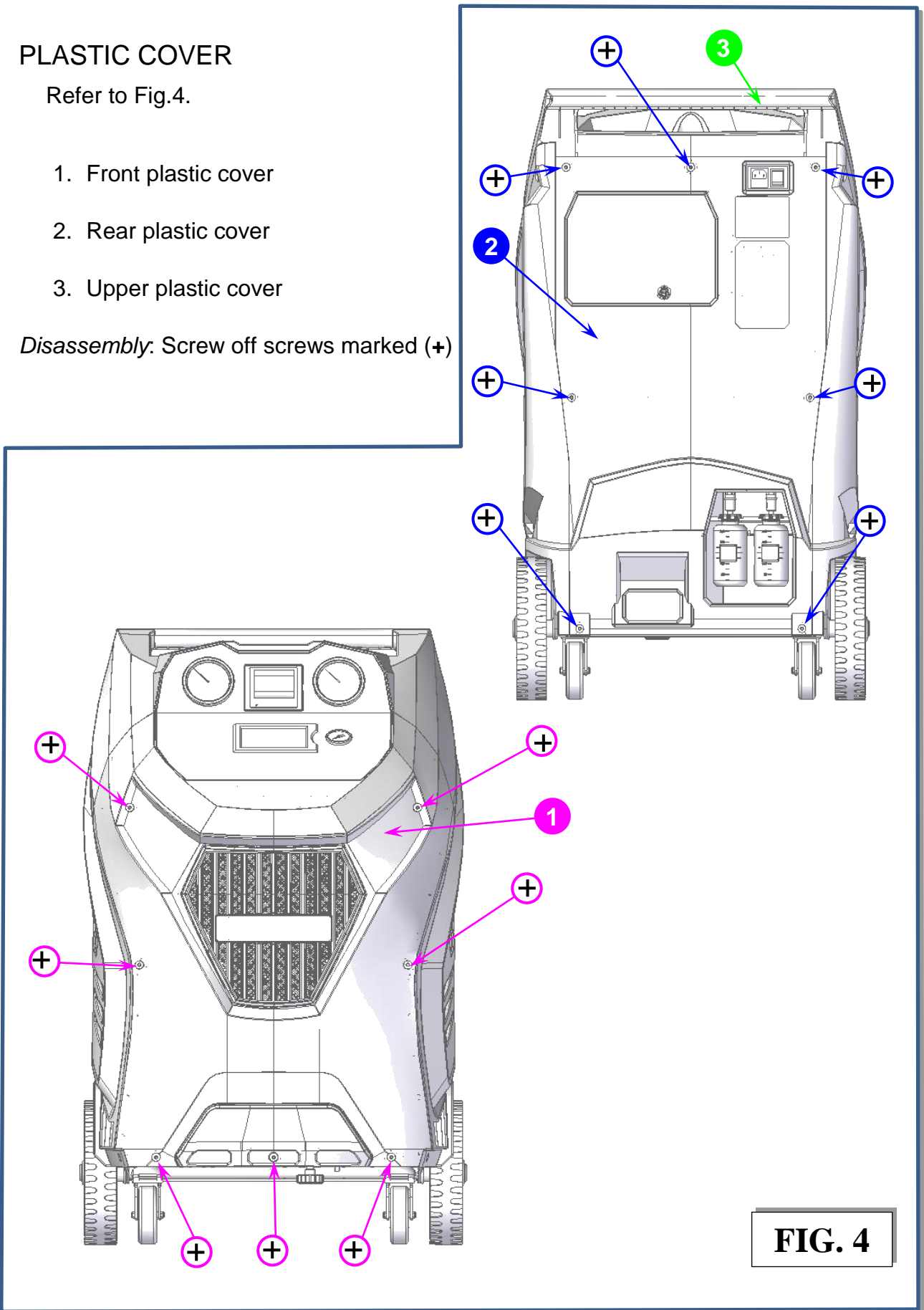
# THE MACHINE

## PLASTIC COVER

Refer to Fig.4.

1. Front plastic cover
2. Rear plastic cover
3. Upper plastic cover

*Disassembly:* Screw off screws marked (+)

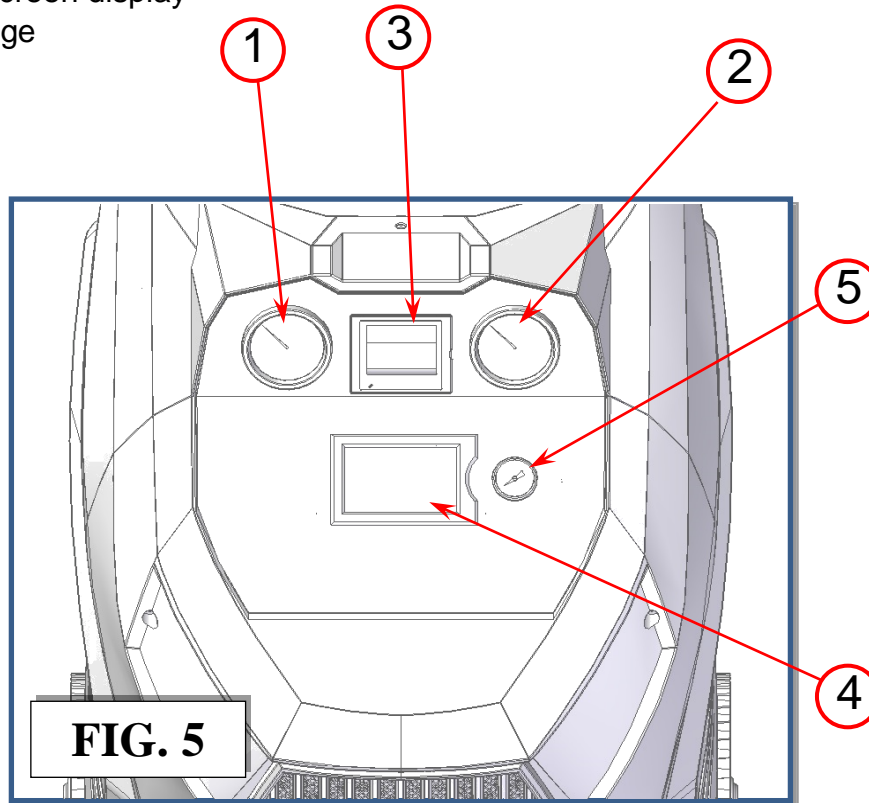














## CONTROL PANEL

Refer to Fig.5:

- 1) High pressure gauge
- 2) Low pressure gauge
- 3) Printer (optional)
- 4) 5" touchscreen display
- 5) Tank gauge



## DISPLAY ICONS

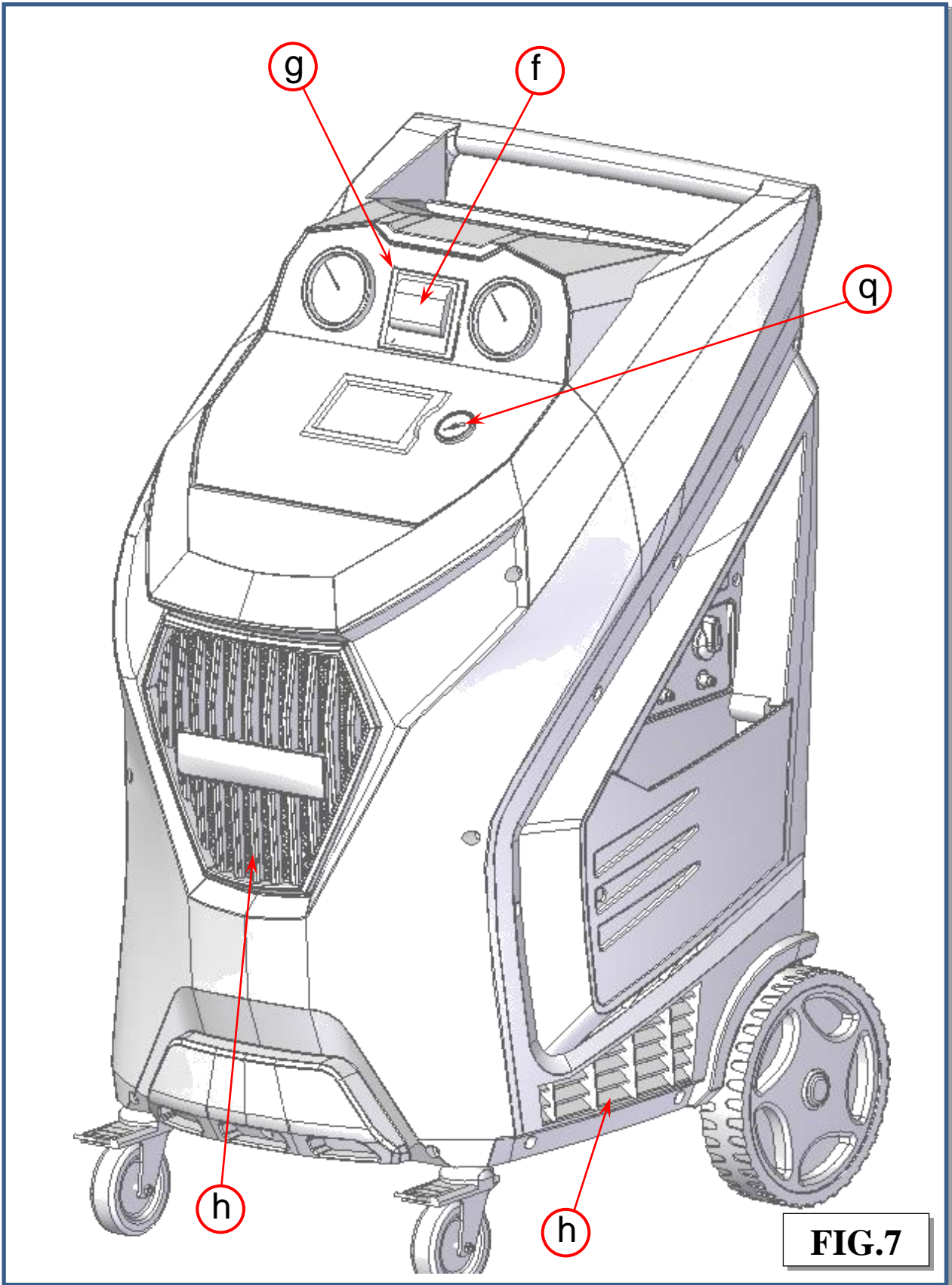
ICON	DESCRIPTION	FUNCTION
	AUTOMATIC PROCEDURE	activates a menu that helps the user set up an automatic recover/vacuum/leak test/charge sequence.
	MANUAL PROCEDURE	activates a menu that helps the user to perform a manual operation:
<b>RECOVERY/RECYCLE</b>	STANDARD RECOVERY	activates a menu that helps the user to perform a recovery/recycling phase (without SAE J-2788 or SAE J-2843 compliance)
<b>VACUUM</b>	VACUUM	activates a menu that helps the user to perform a vacuum phase
<b>OIL INJECTION</b>	OIL INJECTION	activates a menu that helps the user to perform a oil injection followed by a gas filling phase
<b>CHARGE</b>	GAS CHARGE	activates a menu that helps the user to perform a gas CHARGE phase
	SETUP	activates the setup menu of the service station
	MAINTENANCE	activates the maintenance menu of the service station
	DATA	activates a menu that contains all the information of the service station
	ENTER	Enter symbol
	BACK	Back symbol
	STOP	Stop symbol
	PRINT	Print symbol
	ARROW	Arrow symbol

## BASIC COMPONENTS

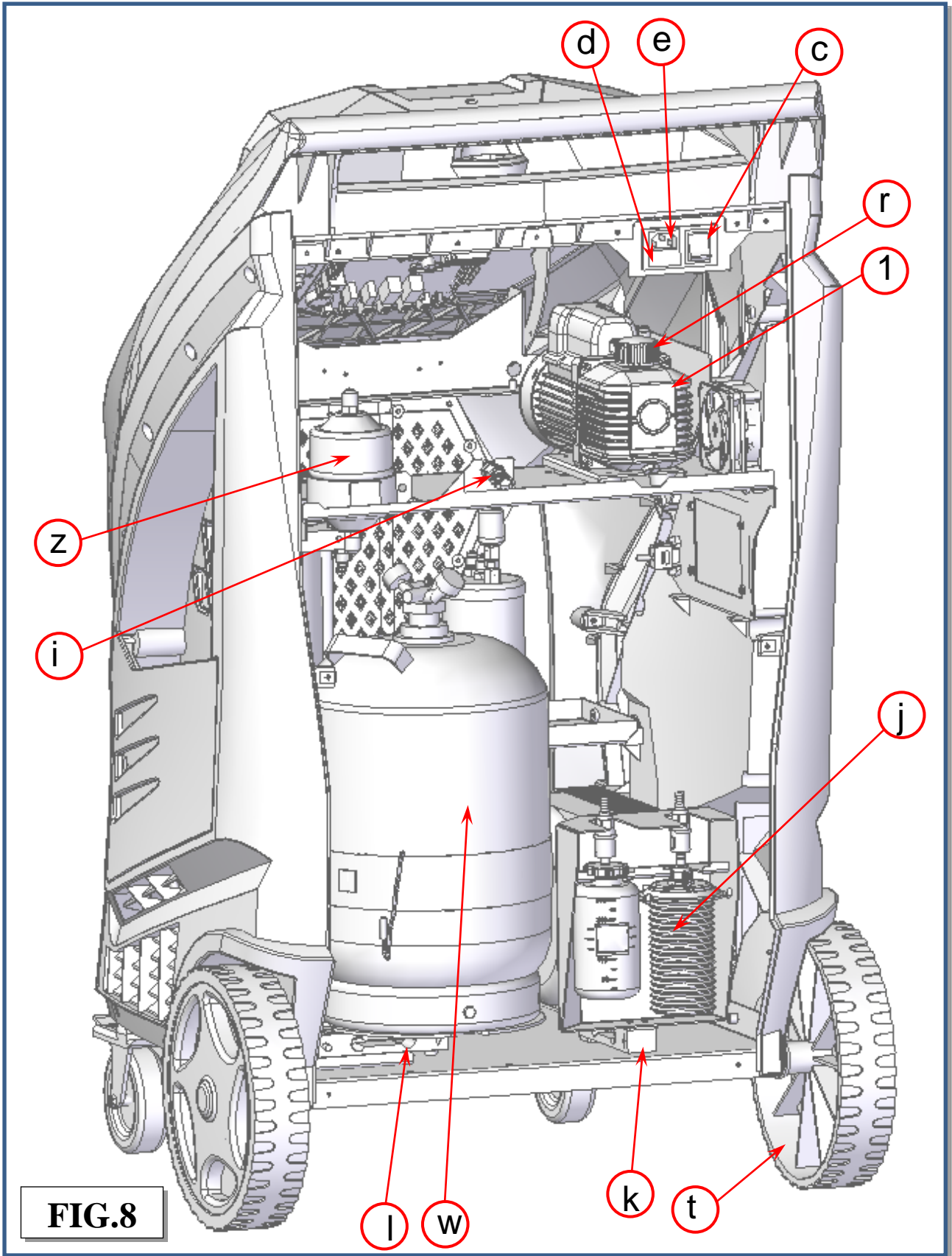
Refer to Fig.7, Fig.8, Fig.9, Fig.10, Fig.11, Fig.12, Fig.13:

- a) USB port
- b) Printer cap
- c) Main switch
- d) Fuse
- e) Socket for electrical supply plug
- f) Printer\*
- g) Printer flange\*
- h) Ventilation grid
- i) Purge valve
- j) Oil cartridge
- k) Oil scale
- l) Tank scale
- m) Condenser + Fan
- n) Front swirling wheel
- o) Manifold
- p) Capsizable control panel
- q) Tank pressure gauge
- r) Oil pump filling cap
- s) Refrigerant tank lock knob
- t) Rear wheel
- u) New oil container
- v) Used oil container
- w) Refrigerant tank
- x) ---
- y) 12V Power supply
- z) Dryer filter
- 1) Vacuum pump
- 2) Compressor
- 3) LP manual valve
- 4) HP manual valve
- 5) LP quick connection
- 6) HP quick connection
- 7) Handle
- 8) ----
- 9) Motherboard

(\*) if installed, depending on machine model



**FIG.7**



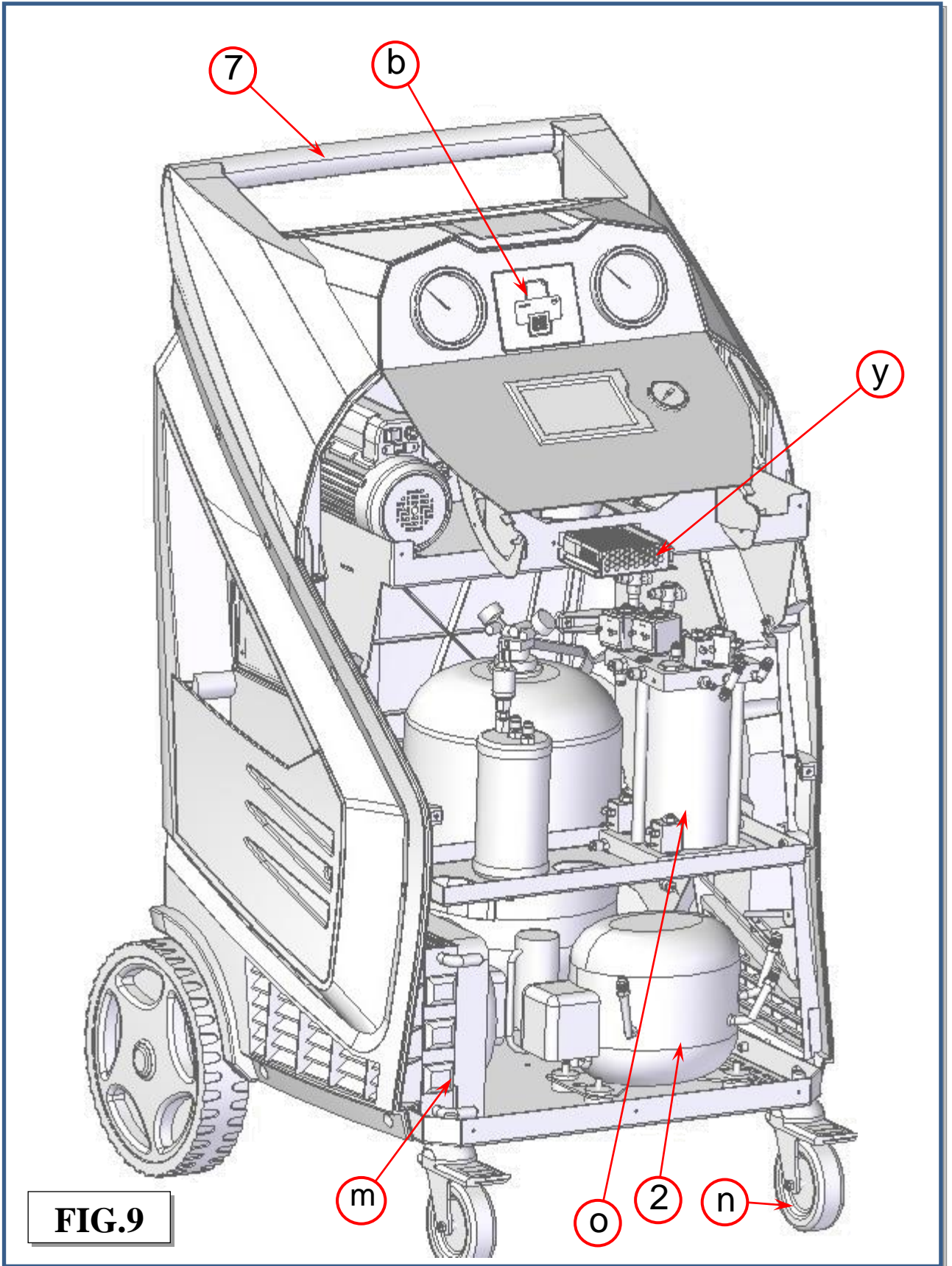
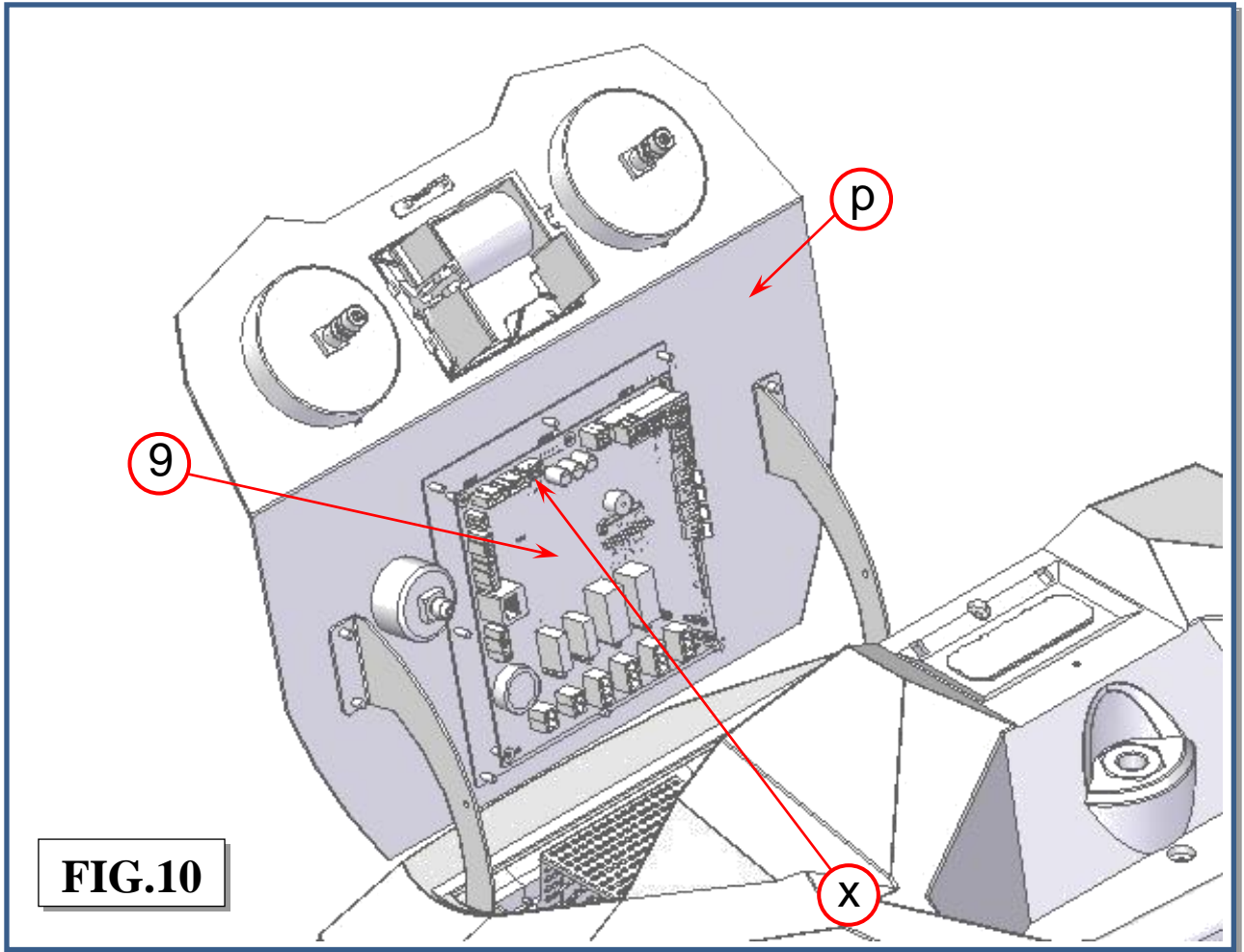
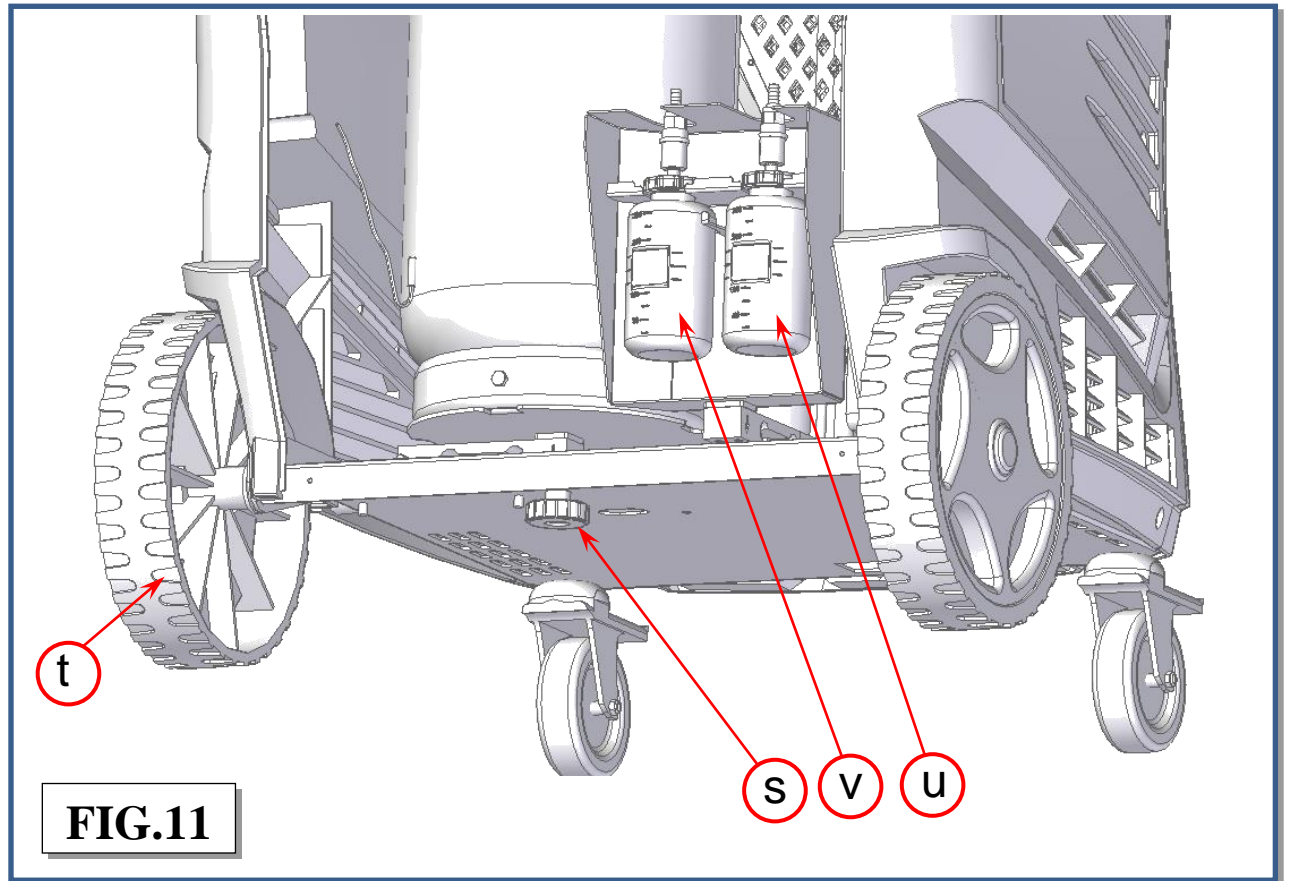


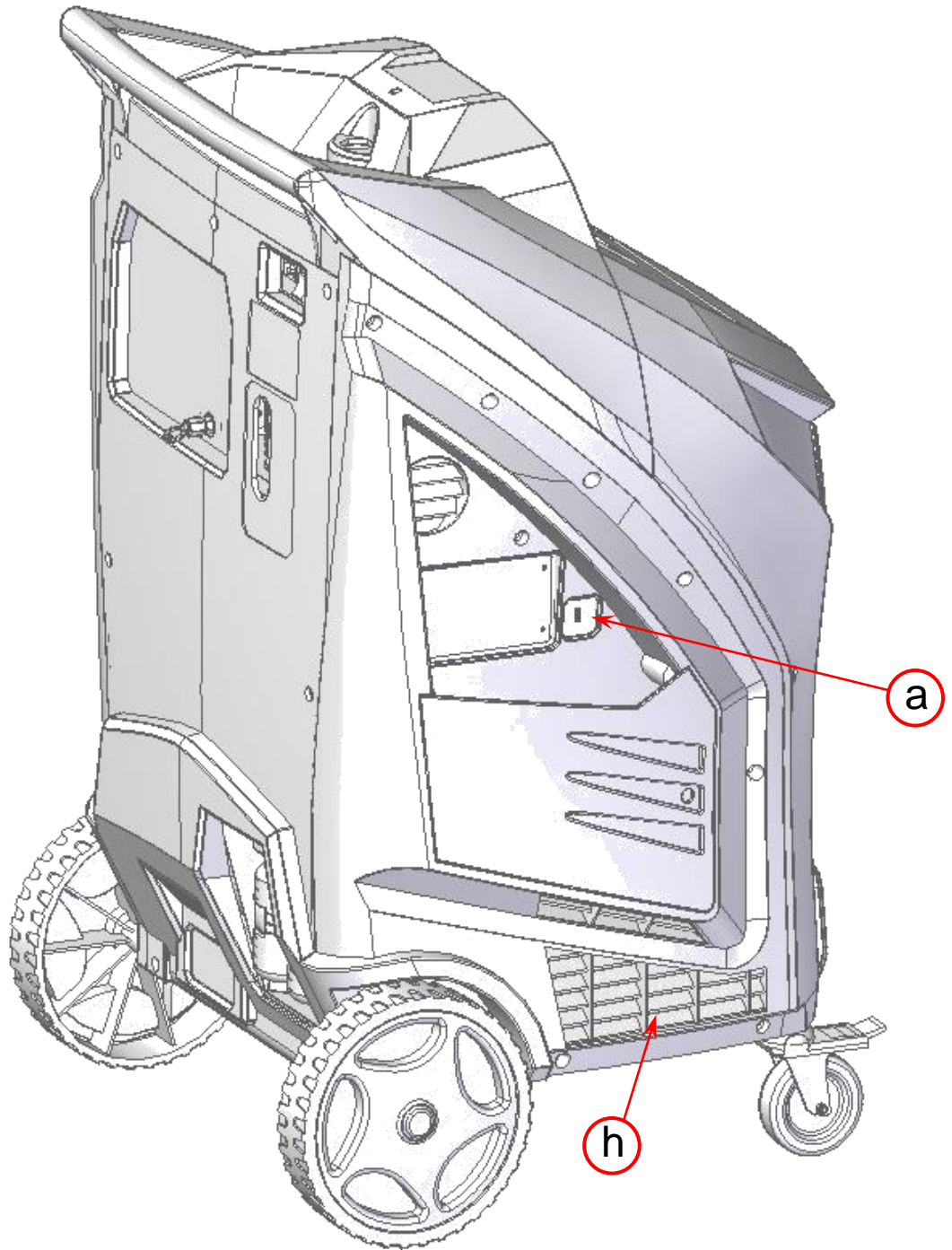
FIG.9



**FIG.10**

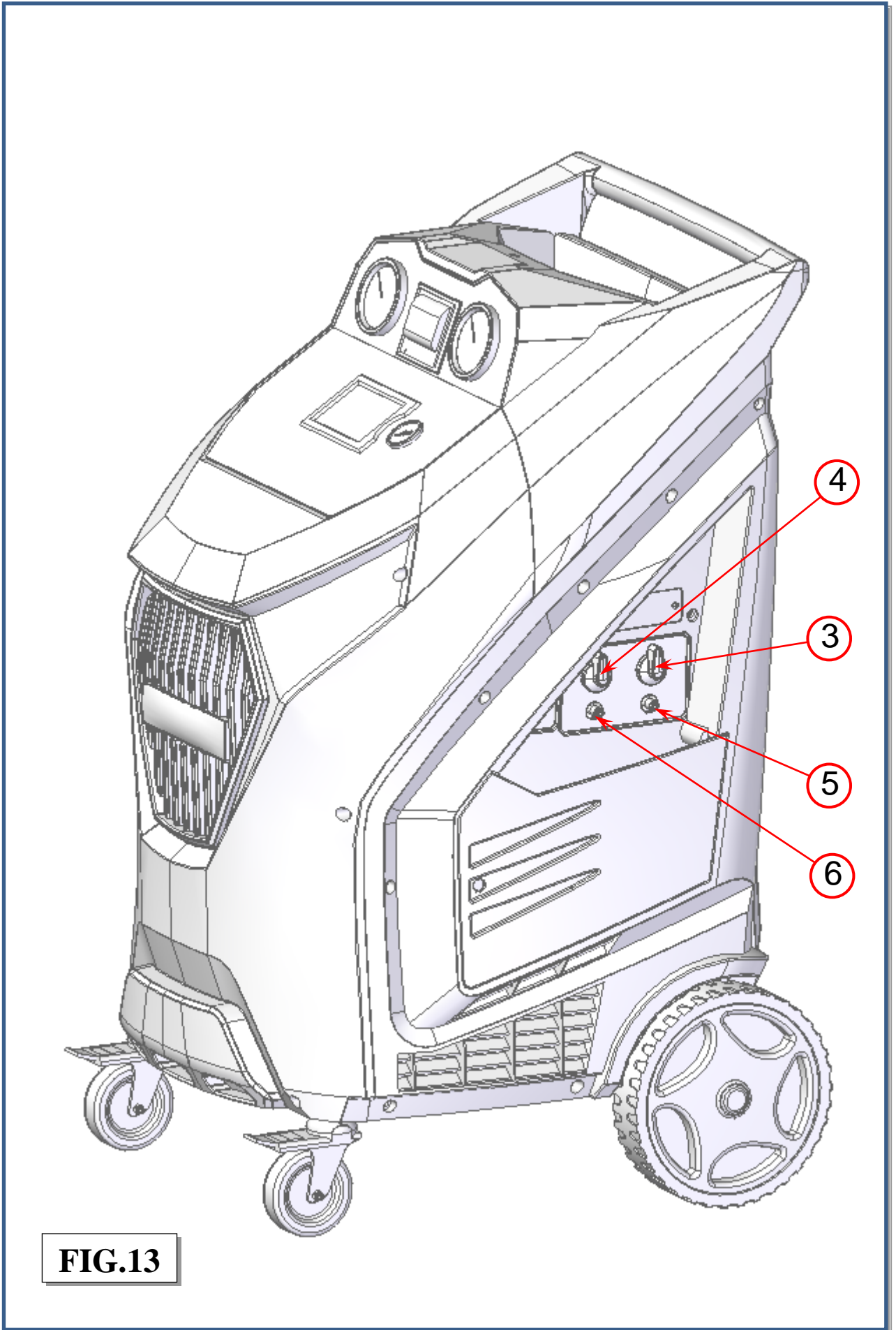


**FIG.11**



**FIG.12**





**FIG.13**

## ALARMS

**HIGH PRESSURE ALARM:** Beeper advise when the pressure of the fluid in the circuit is too high (20bar). The recovery operation is automatically interrupted.

**TANK FULL:** Beeper advise when the tank is filled to more than 80% of maximum capacity (10kg for 12l tank). The RECOVERY operation is automatically interrupted (to cancel this alarm, charge one or more A/C systems before recovering any more refrigerant).

**TANK EMPTY:** Beeper advise when the quantity of refrigerant fluid contained in the tank is low (less than 2kg)

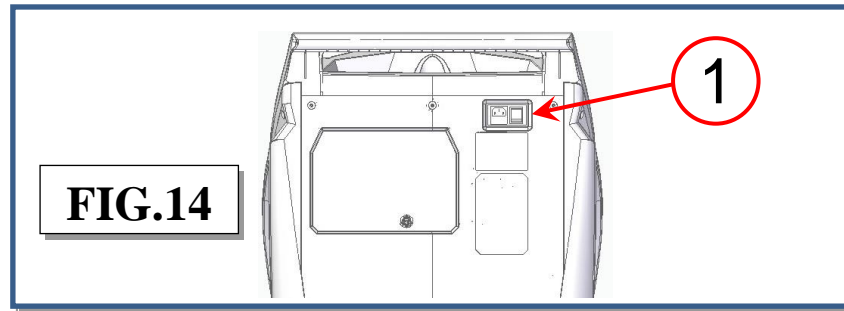
**SERVICE ALARM:** Beeper advise whenever the total recovered refrigerant amounts to 50 kg. To deactivate the alarm, replace the filters and the vacuum pump oil. A code for canceling the alarm is supplied with the spare filters.

## **ERROR CODES**

- SYSTEM LEAKS
- PRESENCE OF REFRIGERANT INTO THE A/C SYSTEM
- LOW VACUUM
- EMPTY TRACER CONTAINER
- EMPTY OIL CONTAINER
- LOW GAS AVAILABILITY
- VACUUM LEAKS (A/C SYSTEM FLUSHING)
- PRESSURE LEAKS (A/C SYSTEM FLUSHING)
- SYSTEM EMPTY
- COMUNICATION ERROR
- LOW OIL VOLUME
- CHECK CONNECTIONS
- EMPTY EXTERNAL BOTTLE
- HIGH PRESSURE ALARM

## PRELIMINARY OPERATIONS

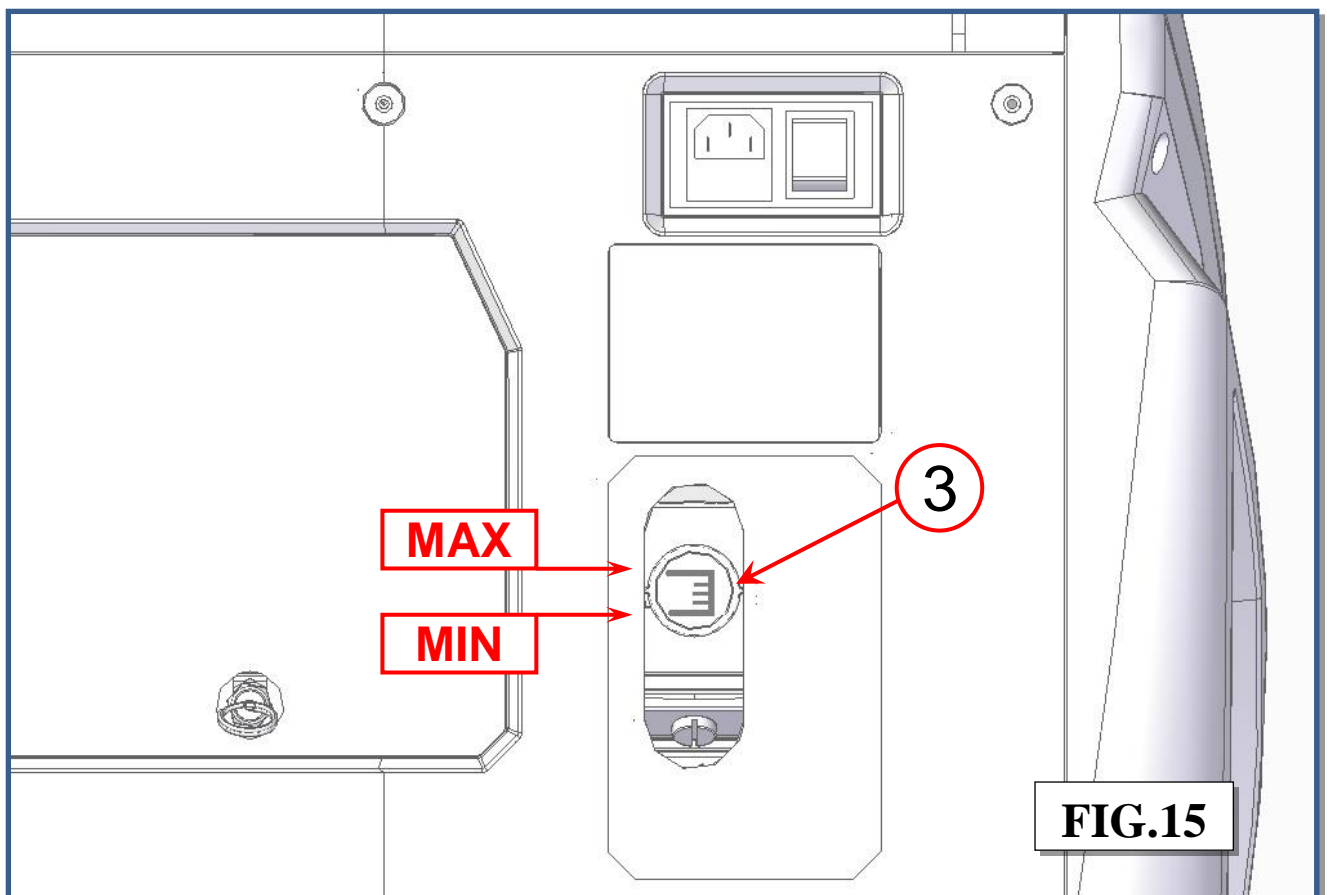
Check that the main switch (ref.1, Fig.14) is set to O. Connect the machine to the electrical supply and switch on.



1 The user can verify the all data of the machine:

- Check that the OIL containers aren't empty, if necessary operate the substitution as described in ORDINARY MAINTENANCE section.
- Check that the oil level in the used oil container is < 200 cc, if necessary empty it as described in ORDINARY MAINTENANCE section.
- Check on the machine display that there are at roughly 2 kg of refrigerant in the tank. Should this not be the case, fill the on-board machine tank from an external tank of appropriate refrigerant following the procedure described in the TANK FILLING (ORDINARY MAINTENANCE)

Check that the vacuum pump oil level indicator (ref.3, Fig.15) shows at least one-half full. If the level is lower, add oil as explained in the MAINTENANCE section.



## QUICKSETUP

The first time the machine is used, a quicksetup guide appears: the operator is guided through the steps described at the start of the PRELIMINARY OPERATIONS section. The quicksetup can also be found in the SETUP MENU, select QUICKSETUP. The following screen is displayed:



Press ENTER to proceed with QUICKSETUP, the user will be guided through the following steps:

- Language
- Measure units
- License plate recording
- Date and time
- Setup header print
- Vacuum settings
- Leak check test
- Tank filling

Follow the instructions displayed. At the end of the procedure, press ENTER to print a summary report of the guided procedure. Press ESC to exit.

**NOTE:** If the guided procedure is not completed, it will be displayed again the next time the machine is switched on.

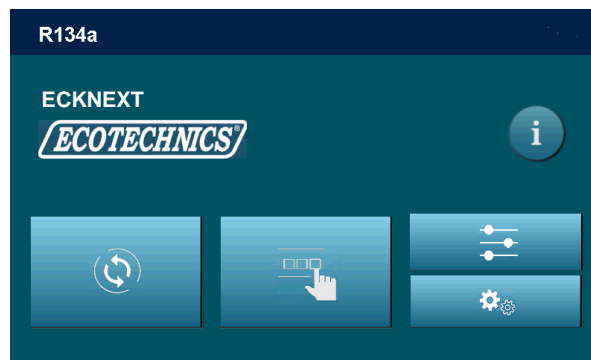
**NOTE:** To display the QUICKSETUP at any time, select from the menu of the same name under SETUP.

## AUTOMATIC PROCEDURE

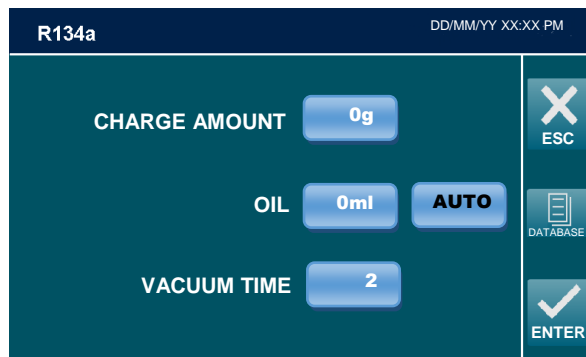
In the automatic mode, all the operations are performed automatically: recovery and recycling, oil discharge, vacuum, new oil reintegration, and charging. The values for the quantity of gas recovered, quantity of oil recovered, vacuum time, quantity of oil reintegrated, and quantity of gas charged into the system are displayed and printed (optional) at the end of each single operation.

Connect the hoses to the A/C system with the quick-connect couplings bearing in mind that BLUE must be connected to the low-pressure side and RED to high pressure. If the A/C system is equipped with a single quick-connect coupling for high or low pressure, connect only the relative hose.

From the MAIN MENU:



Select the AUTOMATIC PROCEDURE , the following screen is displayed:



### EDIT VACUUM DATA:

Use the KEYPAD to insert the new value of the VACUUM TIME, press ENTER to confirm, ESC to return back.

**NOTE: use the VACUUM SETTING to change the duration of the LEAK CHECK.**

### EDIT OIL DATA:

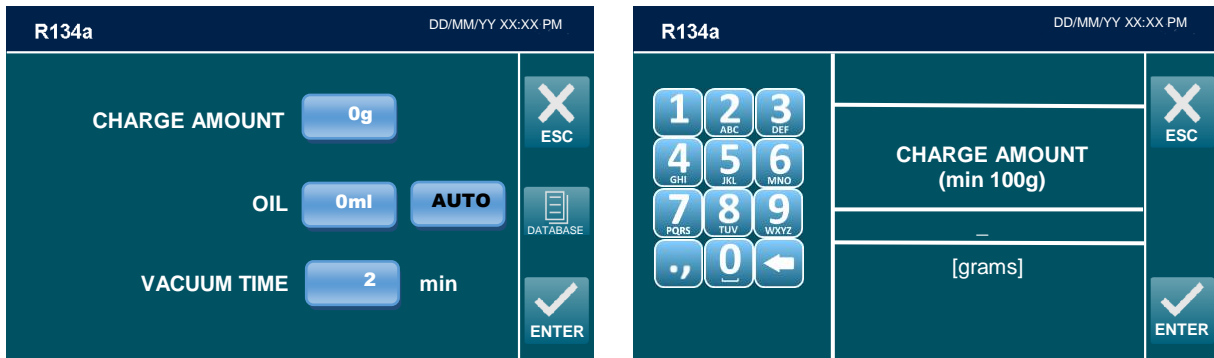
Select the OIL display zone, then use the keys 0 to 9 to type the volume of oil to be injected, or select AUTO to reintegrate the same quantity of oil extracted during Recovery.



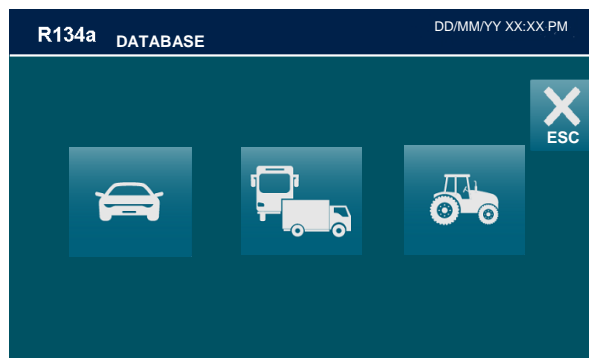
### EDIT GAS FILLING DATA:

**NOTE:** For most systems the quantity of fluid to be refilled is indicated on a plate that is in the vehicle's engine compartment. If this quantity is not known, look for it in the relevant manuals.

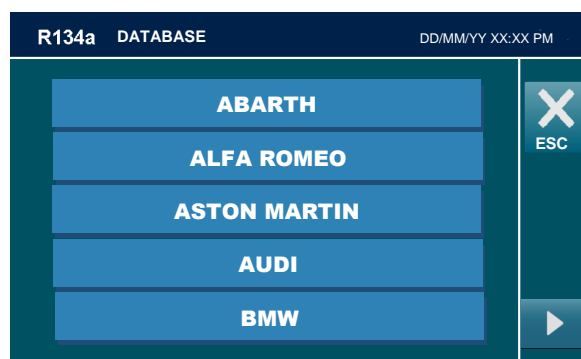
Select CHARGE AMOUNT **0g**, then use the touchscreen keys 0 to 9 to type the quantity (in grams) of refrigerant to be charged into the A/C system.



Or, in installed, press DATABASE button, the following screen will be displayed:



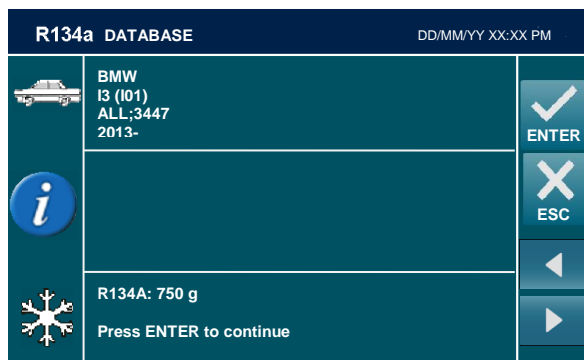
Select the vehicle typology



Select the brand of vehicle you are servicing, (use the arrow keys to change page if necessary), the following screen is displayed (i.e. for BMW):

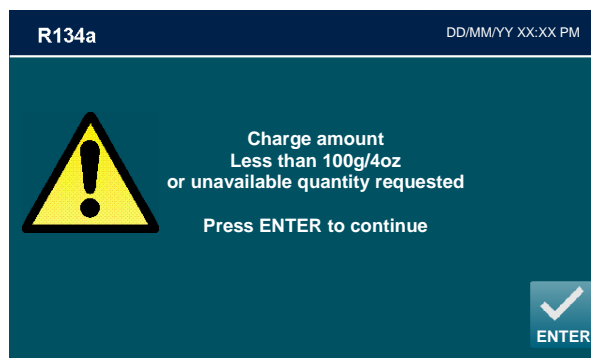


Select the model of vehicle you are servicing. (If you wish to install DATABASE contact the machine dealer.), all the information about this model is displayed:



Press ENTER to confirm, and insert the value into the GAS FILLING field.

**NOTE:** if gas filling is lower than 100 grams the following popup warning will be displayed:



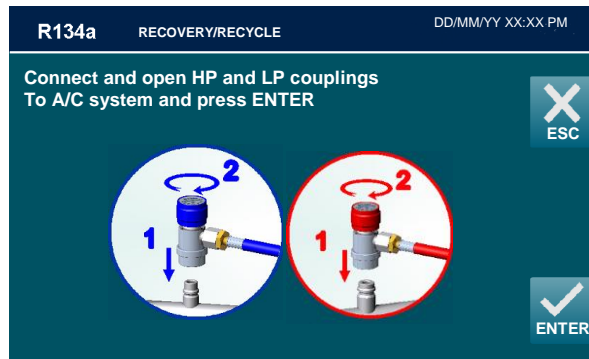
Gas filling lower than 100 grams is not allowed, press ENTER then digit an higher amount of gas filling.



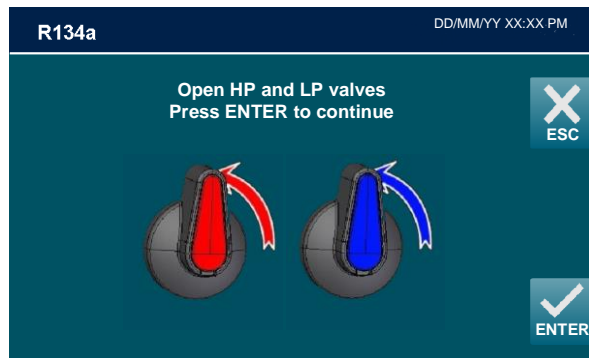
**START AUTOMATIC PROCEDURE:**

After selected all the procedure data, press ENTER to continue.

AUTOMATIC PROCEDURE will start, and the following screen will be displayed:

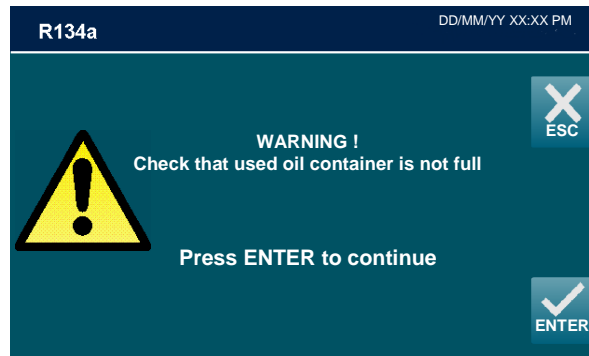


Connect and open the coupling connected to the A/C system, then press ENTER, press ESC to return back

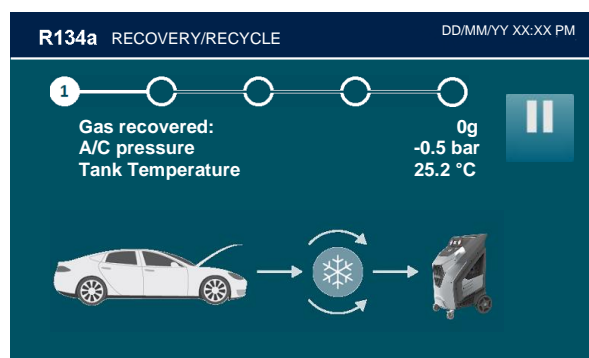


Open HP and LP valves press ENTER to continue,

The following screen will be displayed reminding you to check if the used oil container is not full.

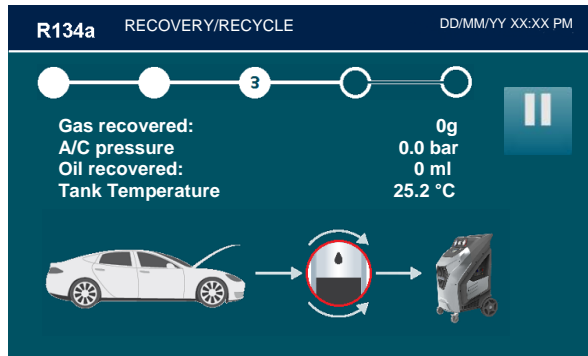


Press ENTER



During the recovery phase, the machine displays the quantity of refrigerant recovered, in grams. Upon completion of recovery, the machine will stop and discharge, while automatically displaying the used oil extracted from the A/C system during the recovery phase.

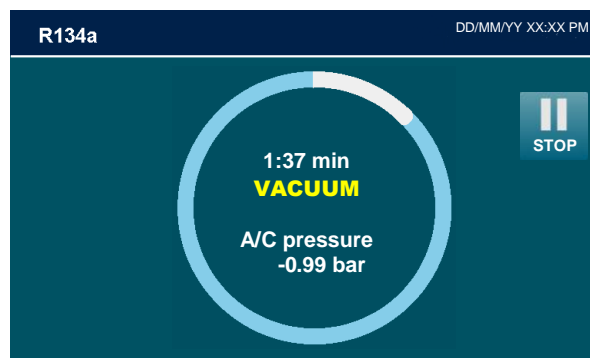
The oil discharge operation lasts 4 minutes.



The machine checks whether or not there is air in the tank and, if necessary, purges the non-condensable gas; The machine will automatically discharge any non-condensable gas.

Allowing the machine to fully complete the procedure will reduce the risk of return flows, which may cause excessive non-condensable gas to be recharged into the air conditioning system. If any residual refrigerant in the A/C system should increase in pressure during this phase, the machine will automatically begin recovering the refrigerant.

Completed the recovery phase, the machine automatically goes on to running the vacuum phase for the preset time:



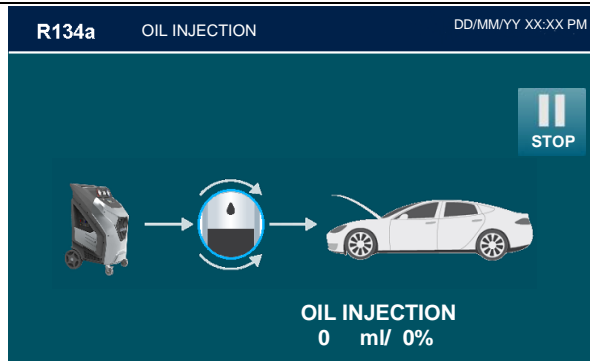
At the end of this phase, the machine will test for leaks in the A/C system:



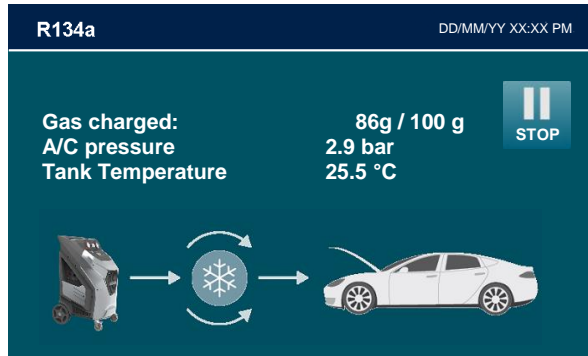
(WARNING! If vacuum time < 15 minutes this test is not reliable). If leaks are found, the machine will stop automatically and display the A/C SYSTEM LEAKS alarm.

Detection of micro-leaks is not guaranteed.

Upon completion of the vacuum phase, new oil will be automatically reintegrated: the volume will be equal to that of the used oil discharged or to the volume set by the operator.

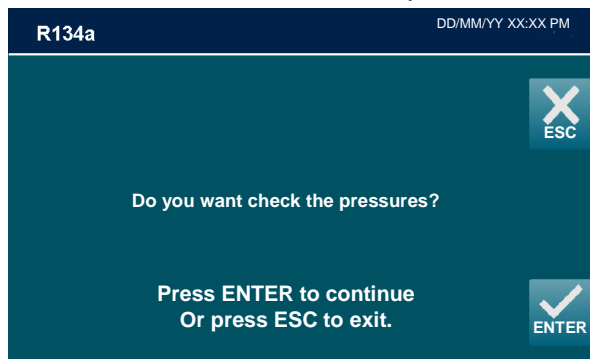


When completed, the system will go on to charging with the preset quantity of refrigerant.

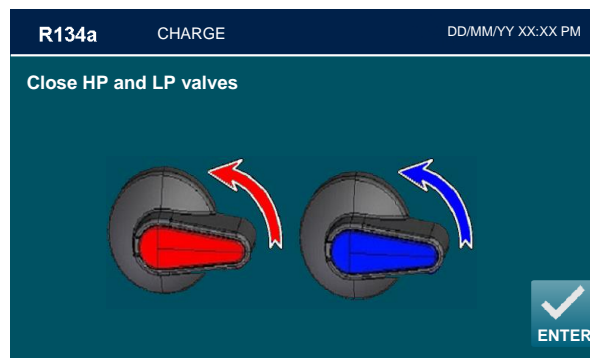


You will be asked if we want to proceed with a pressure control of the AC system.

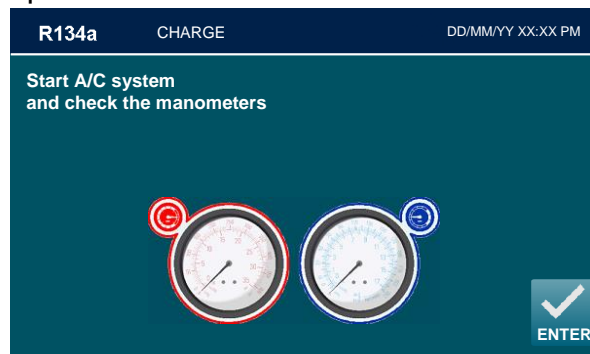
Pressing ENTER to access the test instead with ESC the procedure ends.



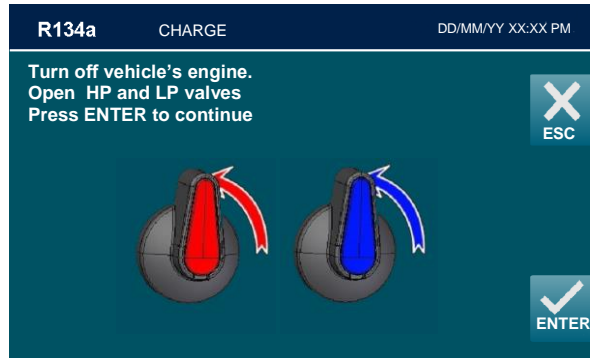
Pressing ENTER you will be asked to close the HP and LP valves.



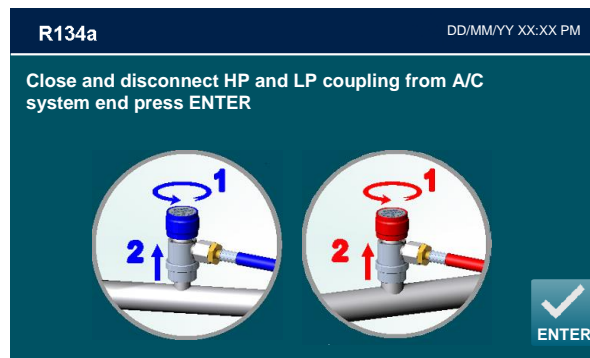
Close HP and LP valves and press ENTER



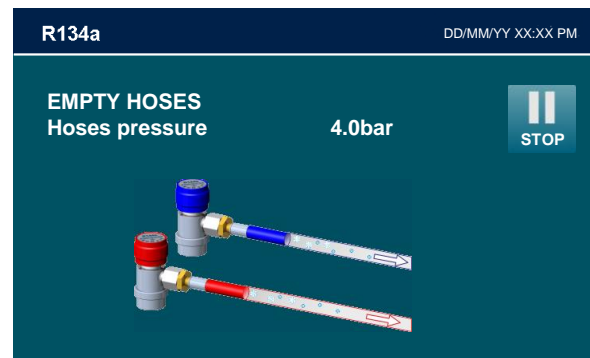
Start A/C system and check the manometers.



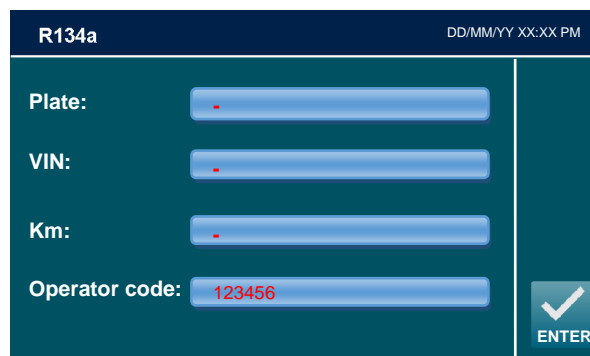
Press Turn off vehicle's engine. Open HP and LP valves. Press ENTER to continue



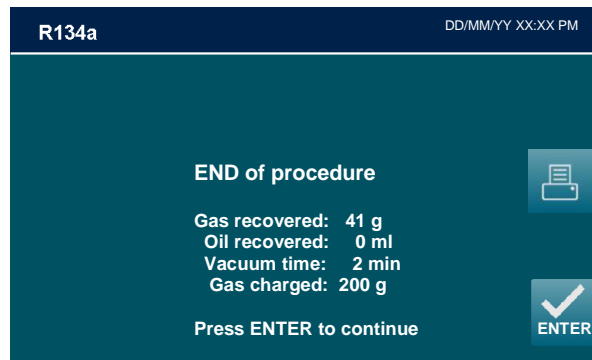
Close and disconnect HP and LP coupling from A/C system end press ENTER to continue:  
Wait for the pressure to equalize between high and low pressure and disconnect the LP fitting.  
Press ENTER



The machine will recover the residual refrigerant into the service hoses, then the following screen will be displayed:



You are asked to enter the vehicle's PLATE, the FRAME NUMBER, the KM and the Operator Code. Press ENTER.



A summary of the amount of gas recovered, oil recovered, minutes of the vacuum phase and the amount of gas charged is displayed.

Press the symbol  for printing (Optional)

Automatic procedure completed successfully, press ENTER to return to the main page.

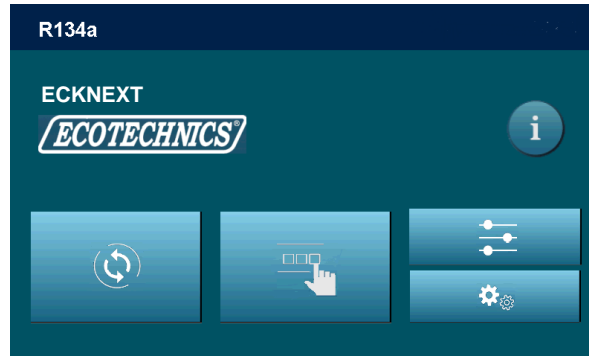
**NOTE:** The automatic procedure may be run even if the A/C system is empty. In this case the machine will begin with the vacuum phase.

## MANUAL PROCEDURE

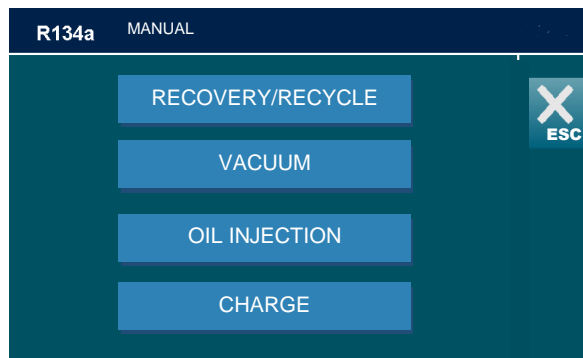
In the MANUAL PROCEDURE, all the operations can be performed singly to the exception of the recovery/recycling phase, which is automatically followed by used oil discharge.

The values for the quantity of gas recovered, quantity of oil recovered, vacuum time, quantity of oil reintegrated, and quantity of gas charged into the system are automatically printed at the end of each single operation.

From the MAIN MENU:



Select the MANUAL PROCEDURE , the following screen will be displayed:

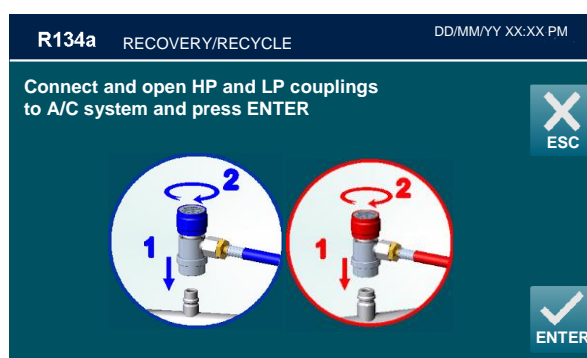


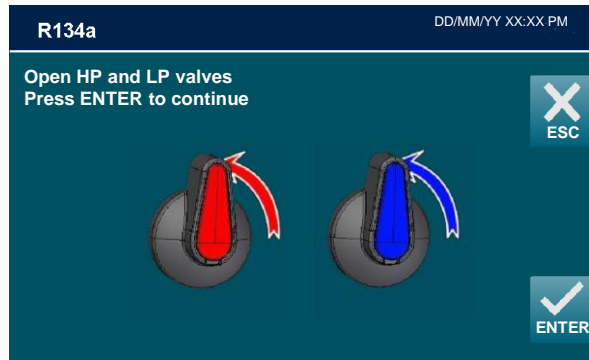
## RECOVERY

Connect the hoses to the A/C system with the quick-connect couplings, bearing in mind that BLUE must be connected to the low-pressure side and RED to high pressure.

If the A/C system is equipped with a single quick-connect coupling for high or low pressure, connect only the relative hose.

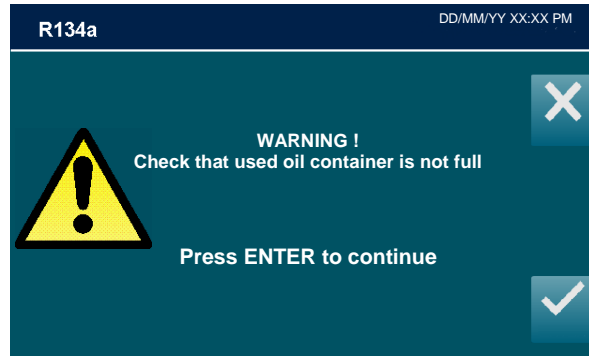
From MANUAL PROCEDURE, RECOVERY/RECYCLE, the following screen will be displayed:



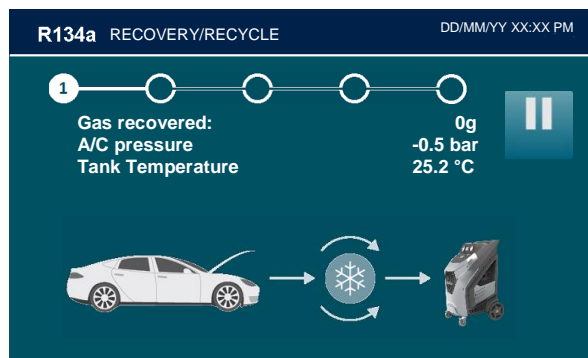


Open HP and LP valves press ENTER to continue,

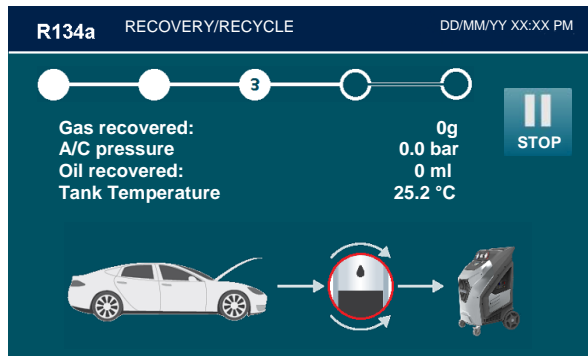
The following screen will be displayed reminding you to check if the used oil container is not full.



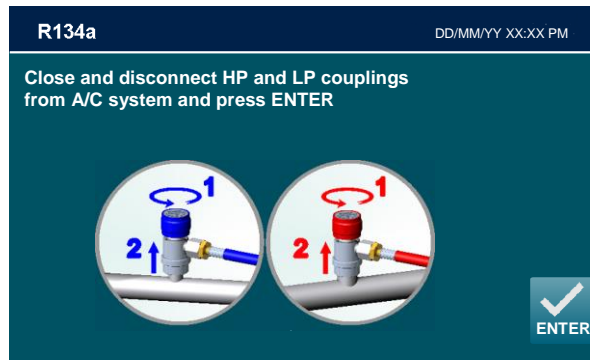
The RECOVERY PROCEDURE will start, and the following screen will be displayed:



During the recovery phase, the machine displays the quantity of refrigerant recovered, in grams.

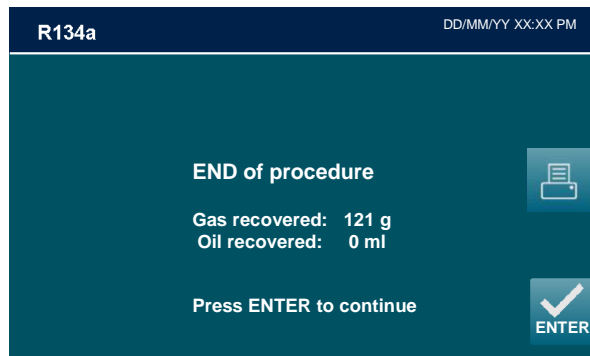


Upon completion of recovery, the machine will stop and discharge, while automatically displaying the used oil extracted from the A/C system during the recovery phase. The oil discharge operation lasts 4 minutes



Unscrew and disconnect HP and LP coupling from A/C system end press ENTER.

You are asked to enter the vehicle's PLATE, the FRAME NUMBER, the KM and the Operator Code. Press ENTER.



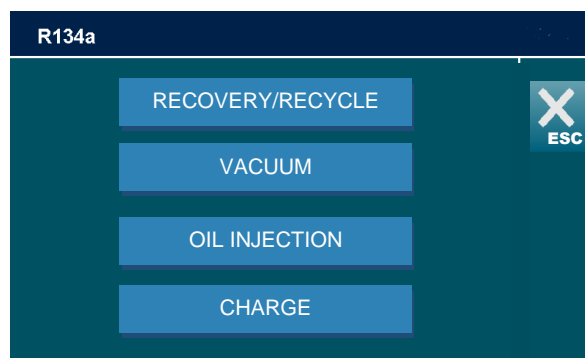
A summary of the amount of gas recovered and oil recovered, is displayed.

Press the symbol  for printing

Manual recovery procedure completed successfully, press ENTER to return to the manual operation page.

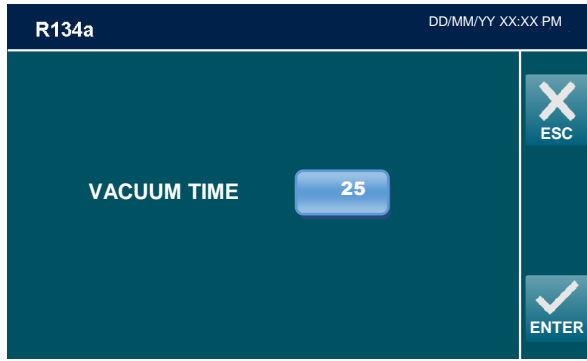
## VACUUM


From the MANUAL PROCEDURE, select VACUUM.

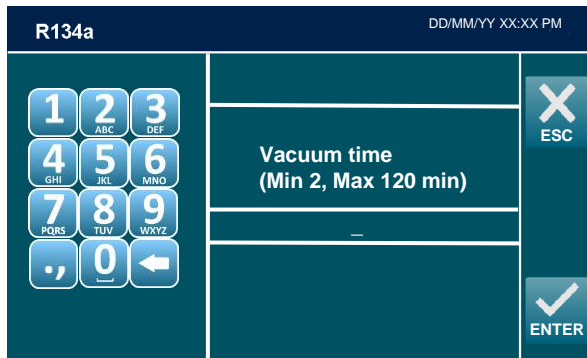


The following screen will be displayed:

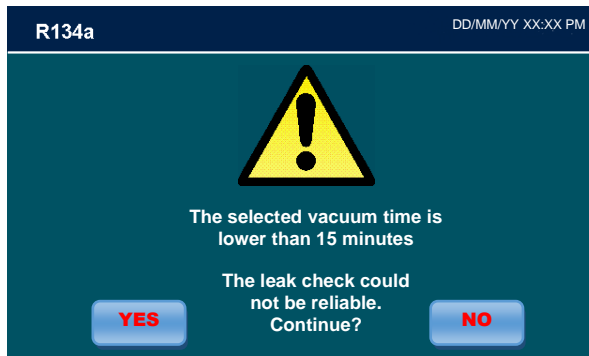




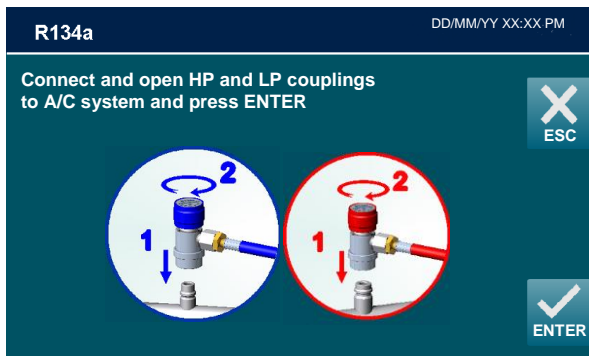
Use the KEYPAD to insert the new value of the VACUUM TIME , press ENTER to confirm, ESC to return back.



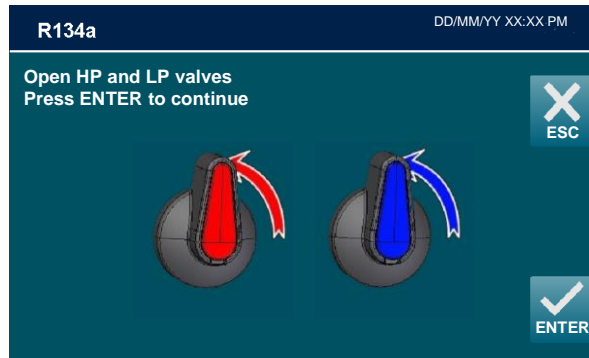
**NOTE:** if selected VACUUM TIME is lower 15 minutes the following popup warning will be displayed:



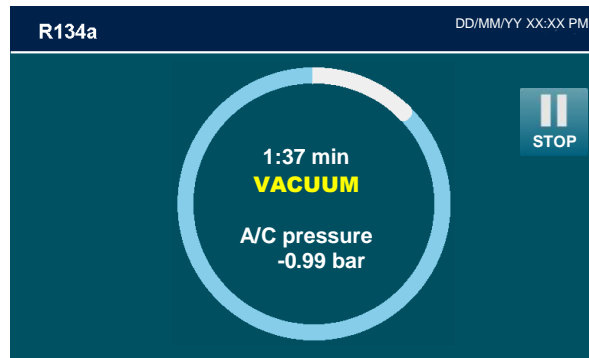
Press YES to continue, or press NO to go back.



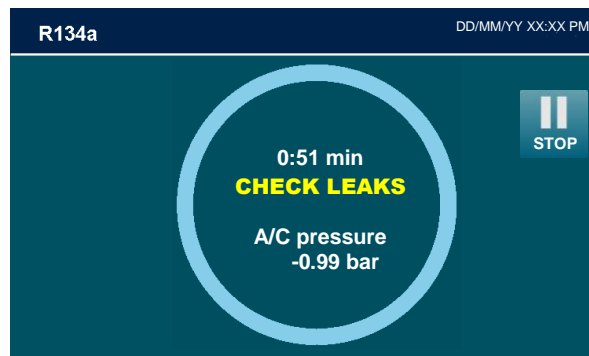
Connect and open the coupling connected to the A/C system, then press ENTER to start the vacuum phase, press ESC to return back.



Open manual valves and press ENTER.



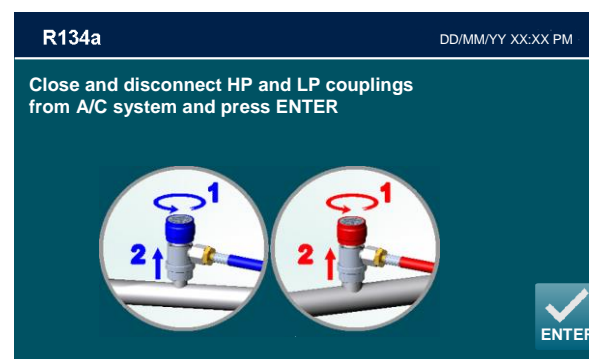
When time of check is reached, the machine will test for leaks in the A/C system:



(WARNING! If vacuum time is lower than 15 minutes this test is not reliable). If leaks are found, the machine will stop automatically and display the A/C SYSTEM LEAKS alarm.

Detection of micro-leaks is not guaranteed.

At the end of the preset vacuum time, the machine will sound and alarm and the following screen will be displayed:



Close and disconnect HP and LP coupling from A/C system, then press ENTER to return to the MAIN MENU; VACUUM PROCEDURE is now successfully completed.

You are asked to enter the vehicle's PLATE, the FRAME NUMBER, the KM and the Operator Code. Press ENTER.

A summary of the amount minutes of the vacuum phase is displayed.

Press the symbol  for printing

VACUUM procedure completed successfully, press ENTER to return to the manual procedure page.


## OIL INJECTION

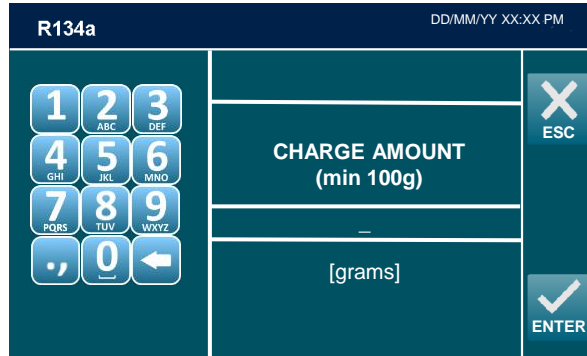
This operation can be carried out ONLY following a VACUUM operation.

From the MANUAL PROCEDURE, select OIL INJECTION:

The following screen will be displayed:

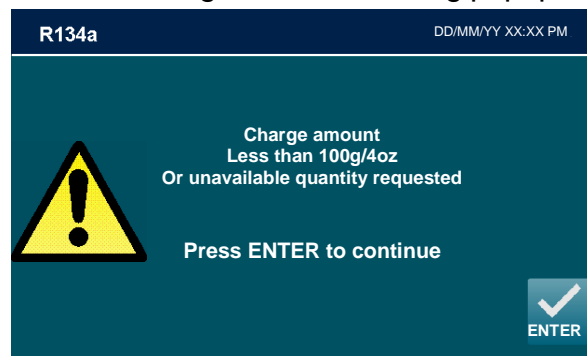
**NOTE:** For most systems the quantity of fluid to be refilled is indicated on a plate that is in the vehicle's engine compartment. If this quantity is not known, look for it in the relevant manuals.

Select the CHARGE AMOUNT quantity field,  see the keypad on the display to enter the amount (in grams) of REFRIGERANT that will be loaded into the A / C system.




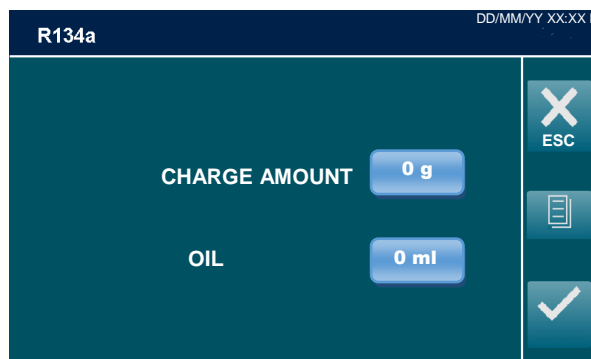
**NOTE:** If DATABASE is installed, can be used to insert the value of refrigerant into the GAS FILLING field.

**NOTE:** if gas filling is lower than 100 grams the following popup warning will be displayed:



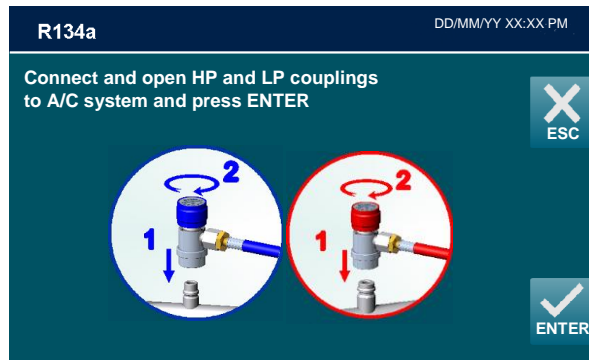
Gas filling lower than 100 grams is not allowed, press ENTER then digit an higher amount of gas filling.

Select the OIL quantity field,  see the keypad on the display to enter the amount (in grams) of OIL that will be loaded into the A / C system.

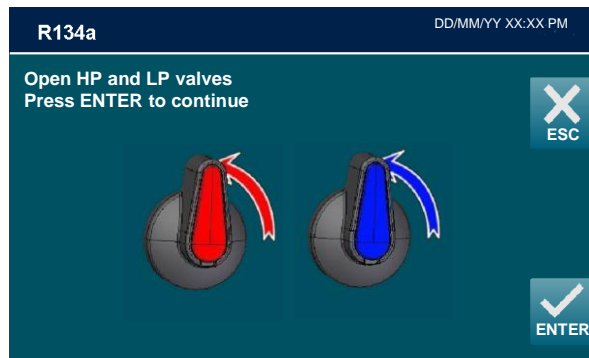


## START PROCEDURE

After selected all the procedure data, press ENTER to continue, the following screen will be displayed:

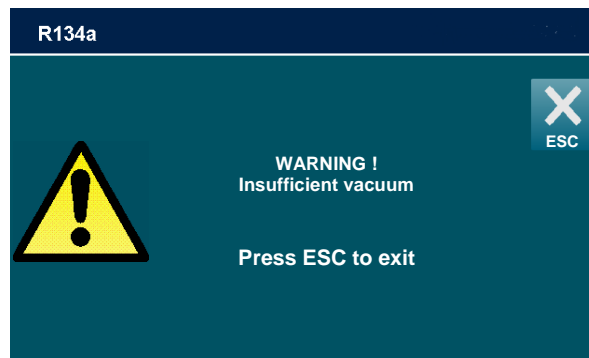


Connect and open the coupling connected to the A/C system, then press ENTER, press ESC to return back.



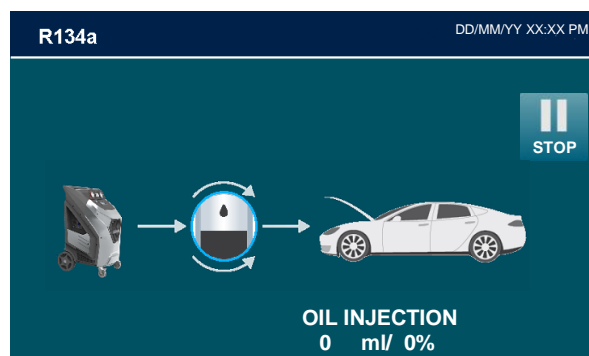
Open manual valves and press ENTER.

If the vacuum is not sufficient, this screen will be displayed:

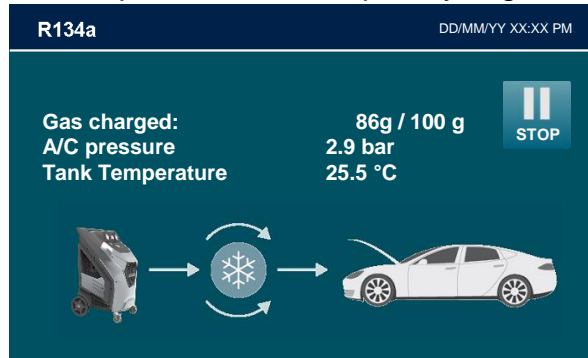


Then run a VACUUM procedure.

Instead with sufficient VACUUM the machine will proceed to inject the amount of oil set

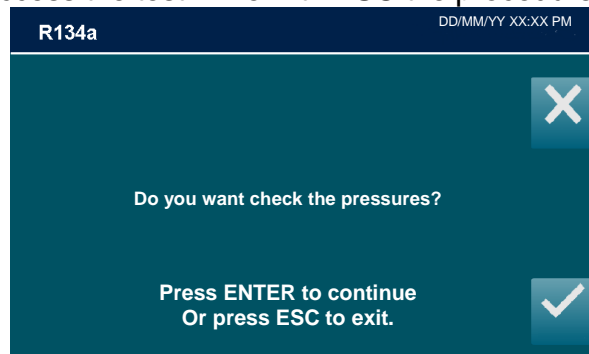


Subsequently the machine will proceed with the quantity of gas set

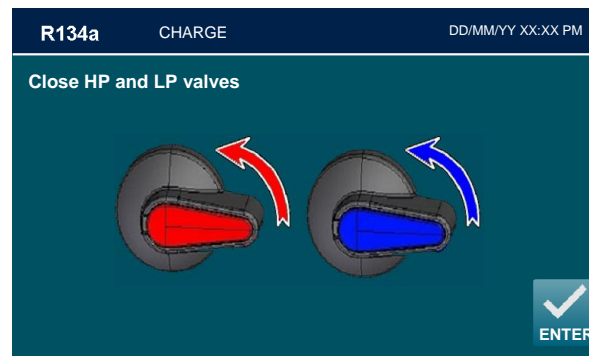


You will be asked if we want to proceed with a pressure control of the AC system.

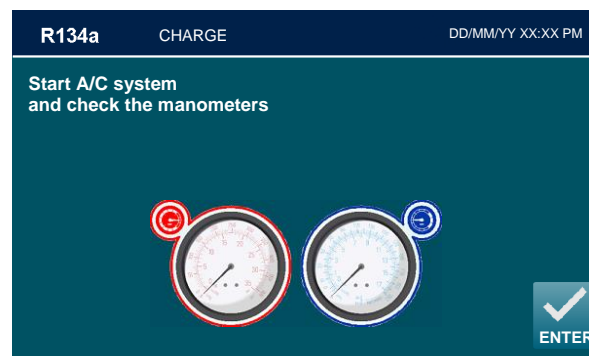
Pressing ENTER to access the test while with ESC the procedure ends.



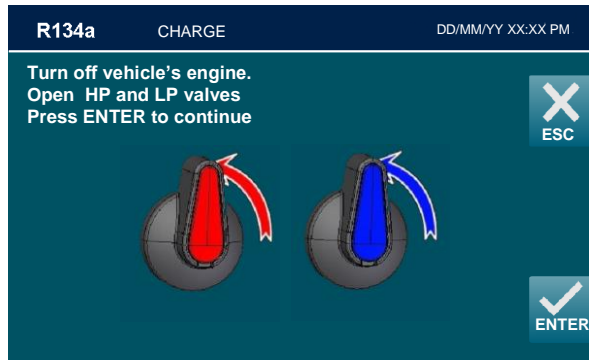
Unscrew LP coupling disconnect from A/C system end press ENTER to continue:



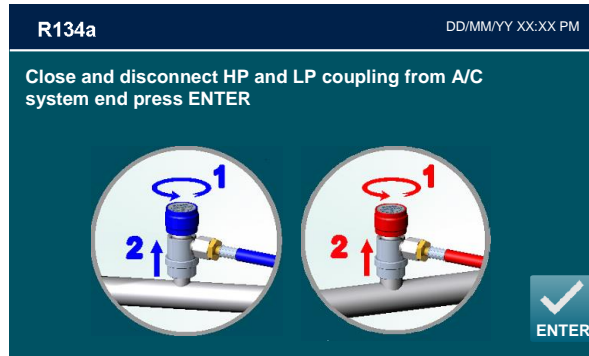
Close HP and LP valves and press ENTER



Start A/C system and check the manometers and press ENTER



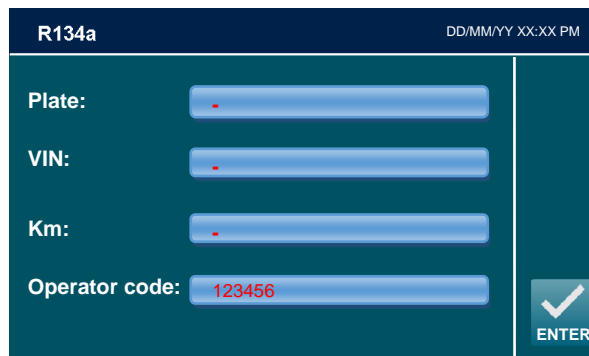
Press Turn off vehicle's engine. Open HP and LP valves. Press ENTER to continue



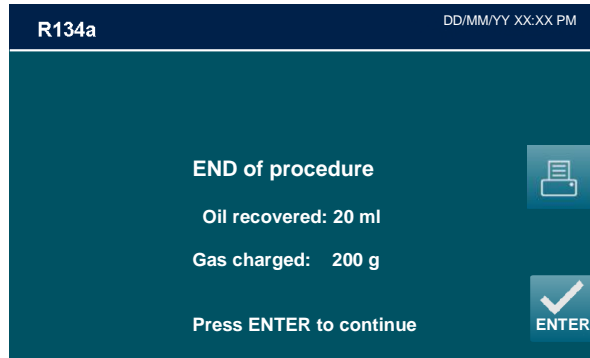
Close and disconnect HP and LP coupling from A/C system end press ENTER to continue:  
Wait for the pressure to equalize between high and low pressure and disconnect the LP fitting.  
Press ENTER



The machine will recover the residual refrigerant into the service hoses, then the following screen will be displayed:



You are asked to enter the vehicle's PLATE, the FRAME NUMBER, the KM and the Operator Code. Press ENTER



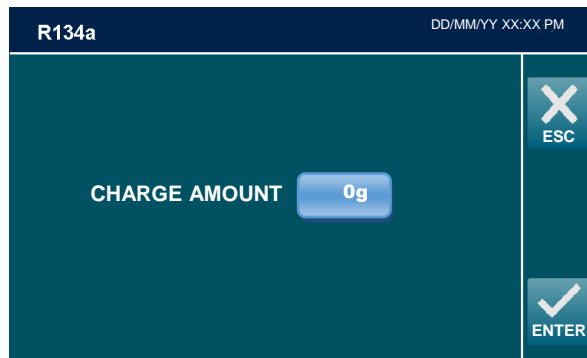
A summary of the amount oil and gas of the OIL INJECTION phase is displayed.

Press the symbol  for printing.


OIL INJECTION procedure completed successfully, press ENTER to return to the manual procedure page.

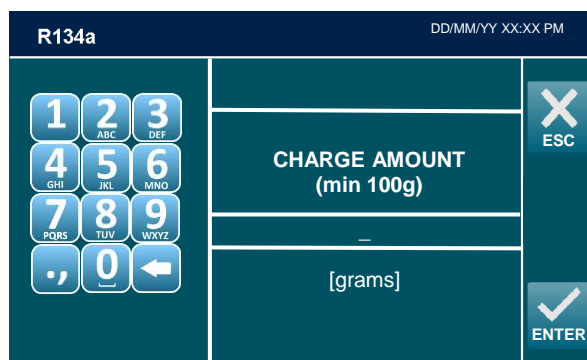
## CHARGE

From the MANUAL PROCEDURE, select CHARGE, the following screen will be displayed:



**NOTE:** For most systems the quantity of fluid to be refilled is indicated on a plate that is in the vehicle's engine compartment. If this quantity is not known, look for it in the relevant manuals.

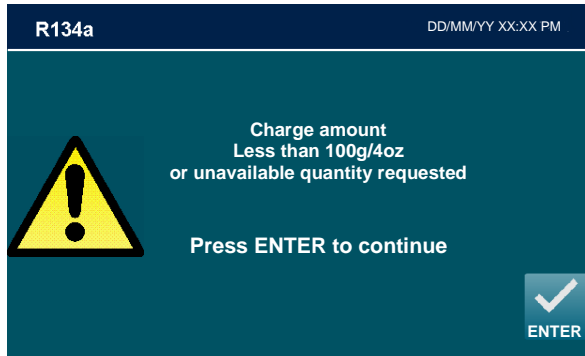
Select the CHARGE AMOUNT quantity field,  see the keypad on the display to enter the amount (in grams) of REFRIGERANT that will be loaded into the A / C system.



**NOTE:** If DATABASE is installed, can be used to insert the value of refrigerant into the GAS FILLING field.

**NOTE:** if gas filling is lower than 100 grams the following popup warning will be displayed:

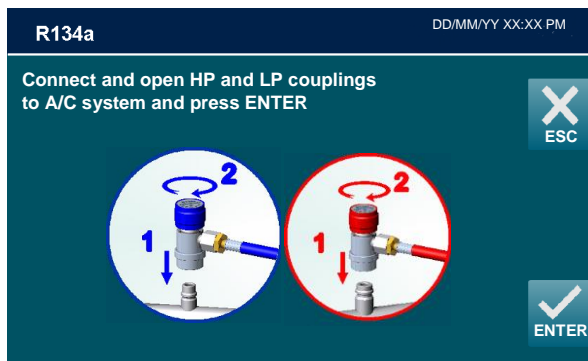




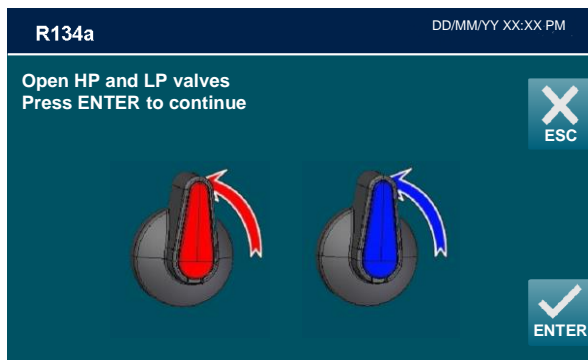
Gas charge lower than 100 grams is not allowed, press ENTER then digit an higher amount of gas filling.

## START PROCEDURE

After selected all the procedure data, press ENTER to continue, the following screen will be displayed:

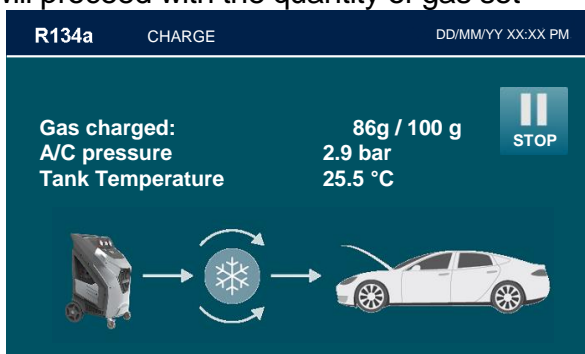


Connect and open the coupling connected to the A/C system, then press ENTER, press ESC to return back.

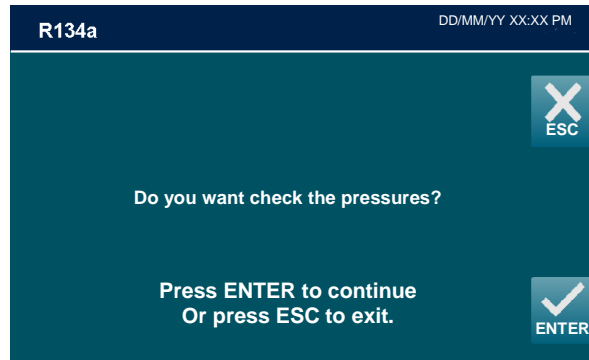


Open manual valves and press ENTER.

Subsequently the machine will proceed with the quantity of gas set

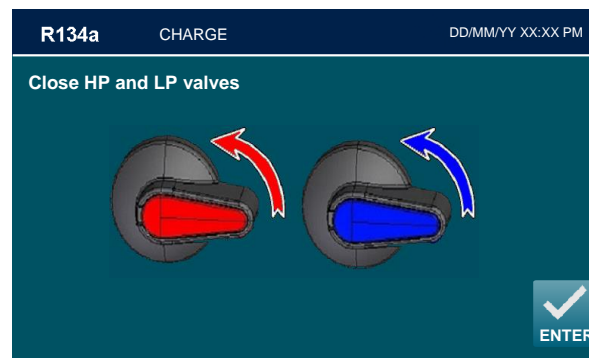


You will be asked if we want to proceed with a pressure control of the AC system.

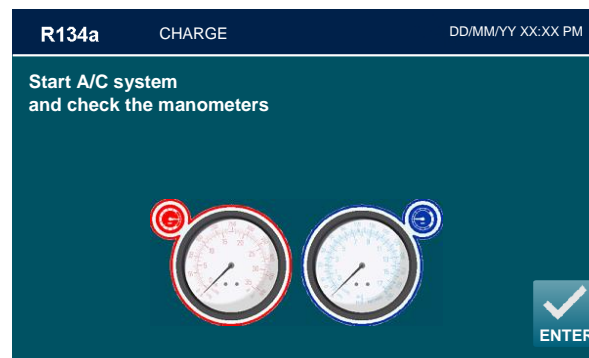


Pressing ENTER to access the test while with ESC the procedure ends.

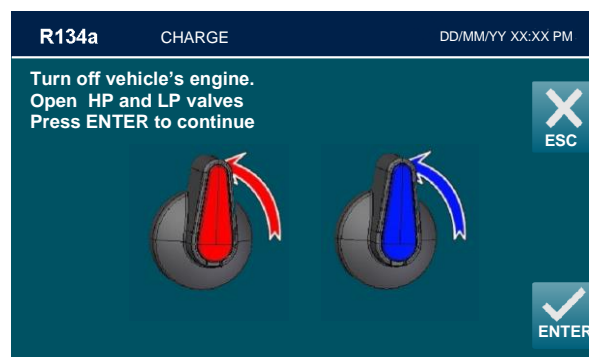
Proceeding with the test unscrew LPcoupling disconnect from A/C system end press ENTER to continue:



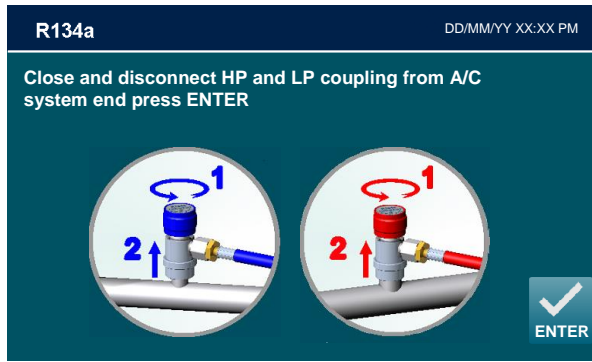
Close HP and LP valves and press ENTER.



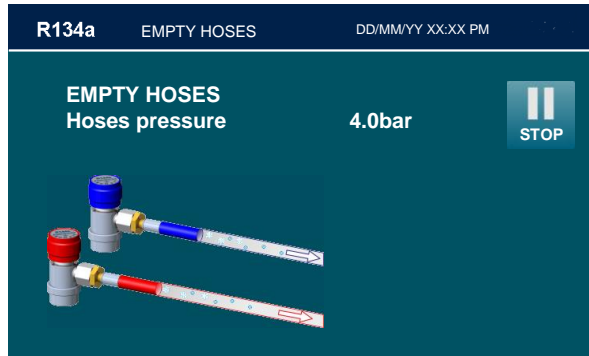
Start A/C system and check the manometers and press ENTER.



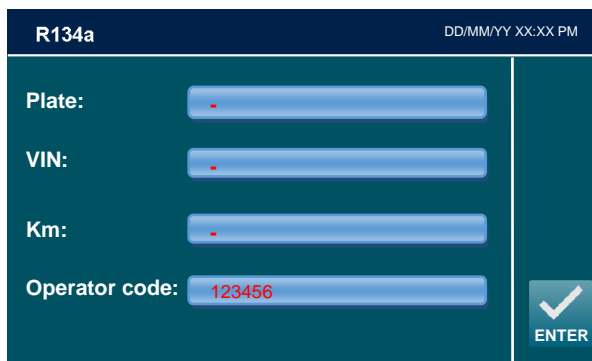
Press Turn off vehicle's engine. Open HP and LP valves. Press ENTER to continue



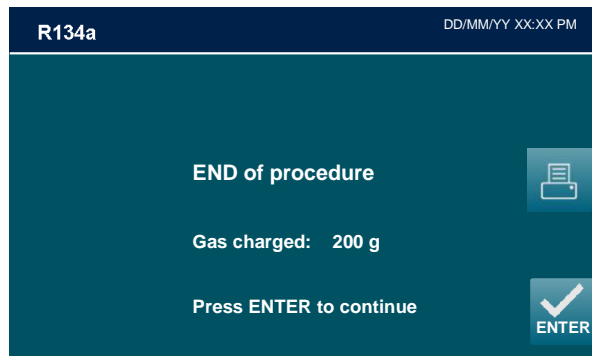
Close and disconnect HP and LP coupling from A/C system end press ENTER to continue:  
 Wait for the pressure to equalize between high and low pressure and disconnect the LP fitting.  
 Press ENTER



The machine will recover the residual refrigerant into the service hoses, then the following screen will be displayed:



You are asked to enter the vehicle's PLATE, the FRAME NUMBER, the KM and the Operator Code. Press ENTER



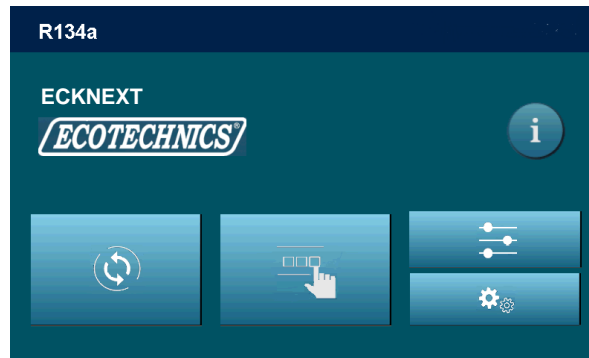
A summary of the amount gas of the CHARGE phase is displayed.

Press the symbol  for printing (Optional)

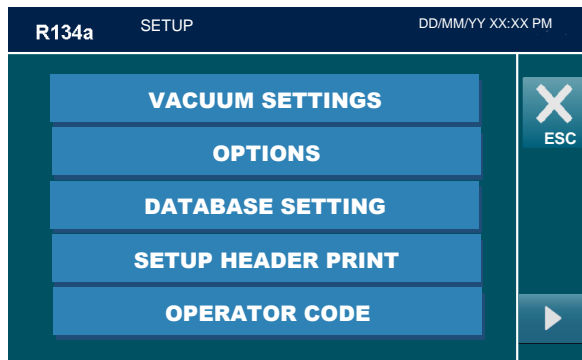
CHARGE procedure completed successfully, press ENTER to return to the manual procedure page.

## SETUP

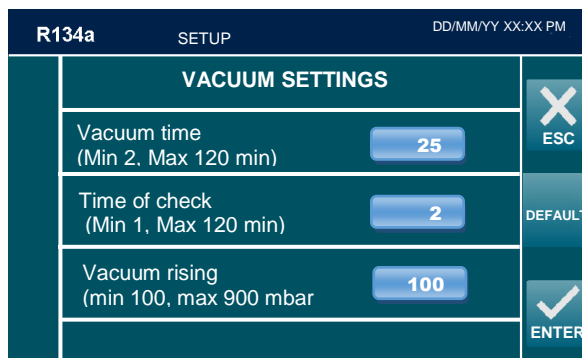
From the MAIN MENU:



Select the SETUP , the following screen will be displayed:



From the SETUP, select VACUUM SETTINGS, default setting is displayed:



Allows to modify the default vacuum time and the default time of check.

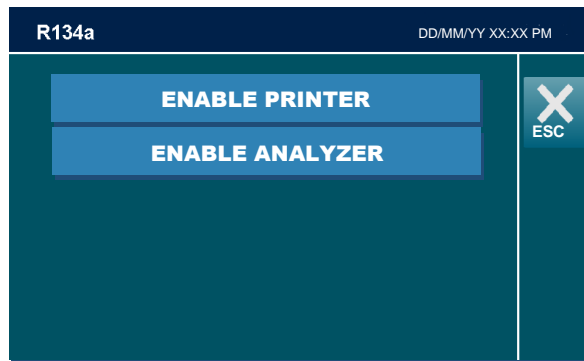
Each value can be modified, within the values shown in parentheses.

**NOTE:** press DEFAULT to restore default values:

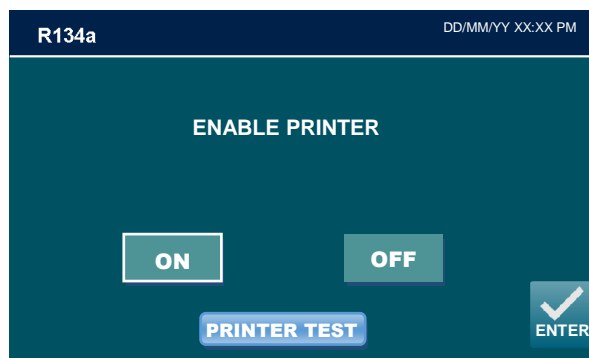
- Vacuum time 25 min
- Time of check 2 min
- Vacuum rising 0,1 mbar

## OPTIONS

Select OPTIONS, insert the OPTION code:43210791 the following screen will be displayed:



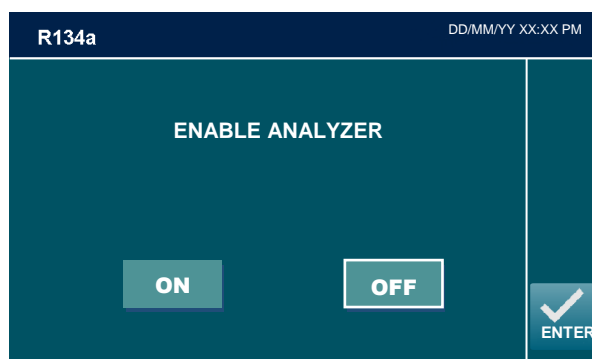
Enable printer (if installed) press ENABLE PRINTER, the following screen will be displayed:



Choose ON to enable the printer and OFF to disable it then press ENTER.

By pressing the button **PRINTER TEST** you can run a test print

Enable ANALYZER (optional) press ENABLE ANALYZER, the following screen will be displayed:



Choose ON to enable the ANALYZER and OFF to disable it then press ENTER.

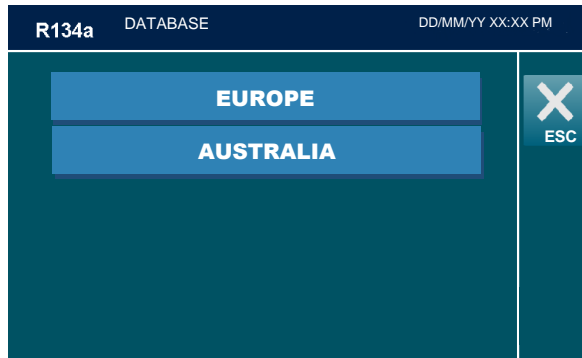
### **GAS ANALYZER**<sup>(optional)</sup>

From the MAINTENANCE MENU, select GAS ANALISYS:

Then select GAS ANALYZER; if gas analyzer is installed, The machine will test the purity of the refrigerant gas in the A/C system (refer to Gas analyzer instruction).

## DATABASE SETTING

Select DATABASE SETTING, the following screen will be displayed:

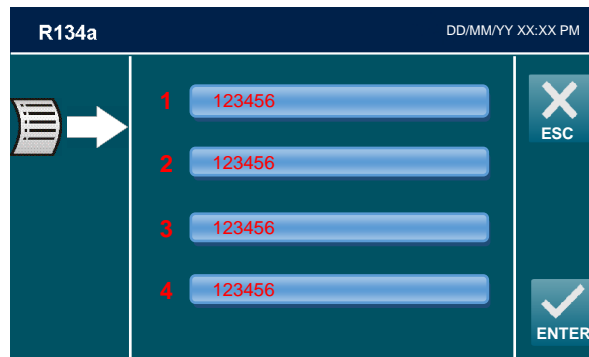


The machine can be set on the EUROPE or AUSTRALIA database.

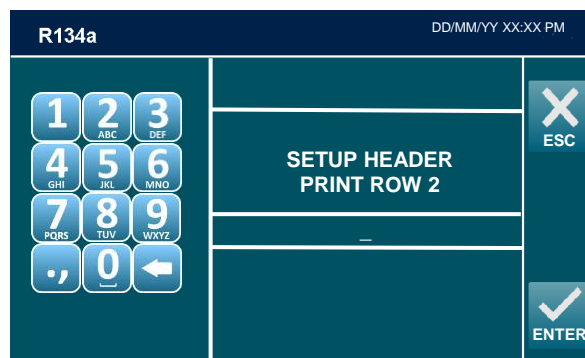
## SETUP HEADER PRINT

The printout can be personalized by entering 4 lines containing the workshop's details (e.g. Name, address, telephone n° and e-mail).

From the SETUP, select SETUP HEADER PRINT:



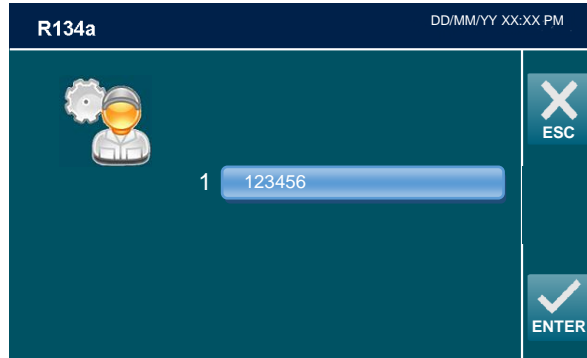
Use the keypad to modify the 4 lines, then press ESC to return to SETUP menu.



**NOTE:** the numerical keys include an alphabet that is used similar to text messaging; for example: press "2" once to display "A", twice to display "B", three time for "C", four time for "2"

## INSERT OPERATOR NUMBER

From the SETUP, select INSERT OPERATOR NUMBER:




It is possible to enter an alphanumeric code of 10 symbols to indicate the habilitation nr of the operator. This number will be indicated in all printouts.

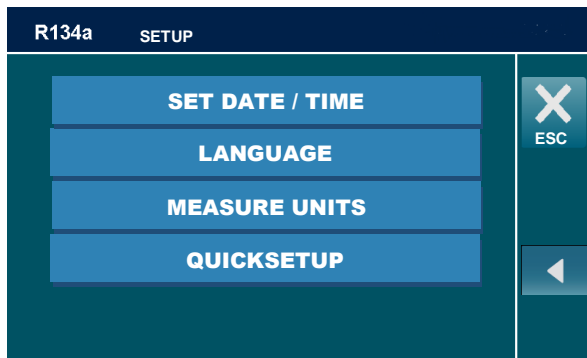


Use the keypad to modify operator number, then press ENTER to return to SETUP menu.

**NOTE:** the numerical keys include an alphabet that is used similar to text messaging; for example: press “2” once to display “A”, twice to display “B”, three time for “C”, four time for “2”

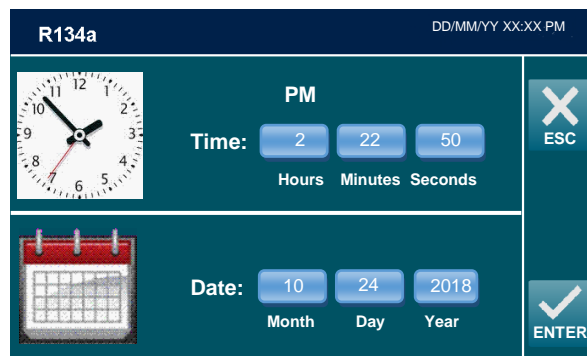
## SET DATE / TIME

From the SETUP, select the arrow  to change page



The machine keeps date and time settings even if it is not used for around one year.

From the SETUP MENU, select SET DATE / TIME:



Use keypad to change date and time, press ENTER to confirm, or press ESC to return to SETUP menu without saving the changes.


## LANGUAGE

Select then LANGUAGE :

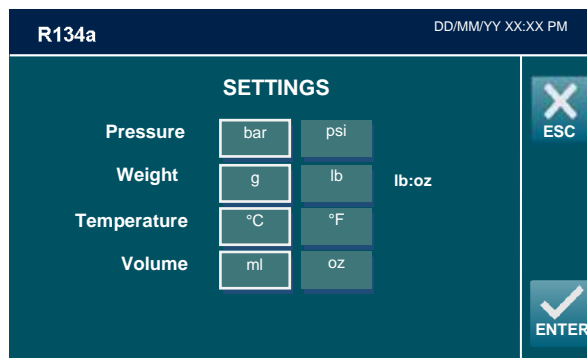


Select a language.

## MEASURE UNITS

From SETUP menu, Select the arrow  to change page.

Select then MEASURE UNITS:



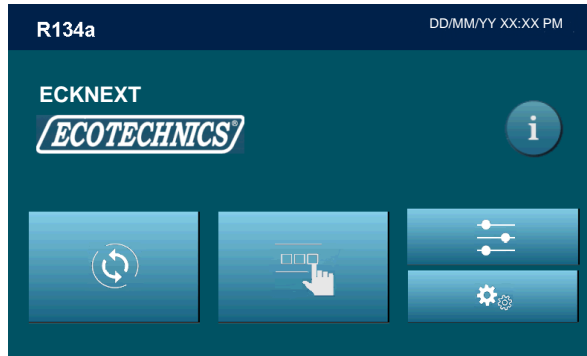
**NOTE:** current MEASURE UNITS is indicated by squaring.

Select a MEASURE UNITS, then press ENTER.

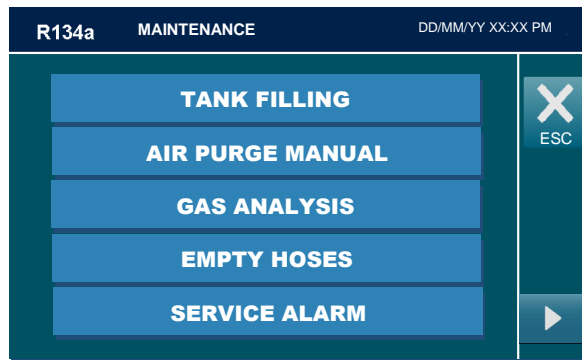


# MAINTENANCE

From the MAIN MENU:



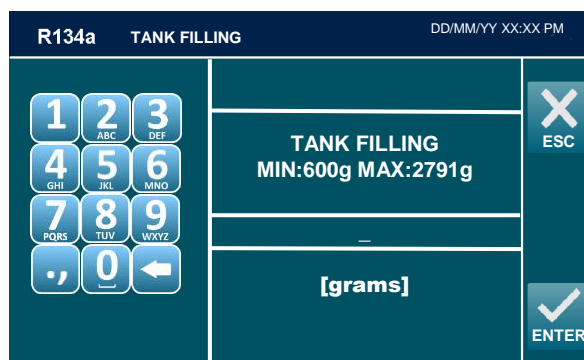
Select the MAINTENANCE  
, the following screen will be displayed:



## TANK FILLING

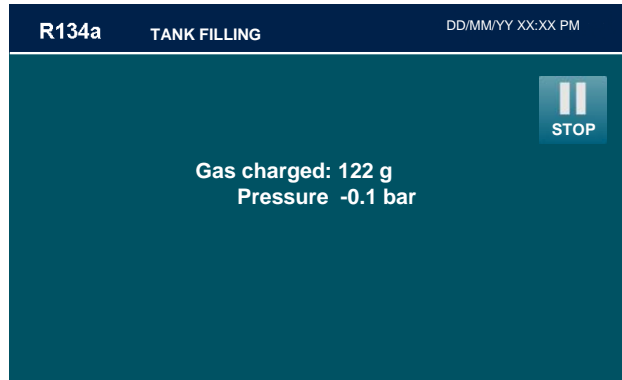
This operation must be performed whenever the available refrigerant fluid in the tank is less than 3 kg and must in any case be performed when the “empty tank” alarm is displayed.

From MAINTENANCE, select TANK FILLING, the following screen will be displayed:

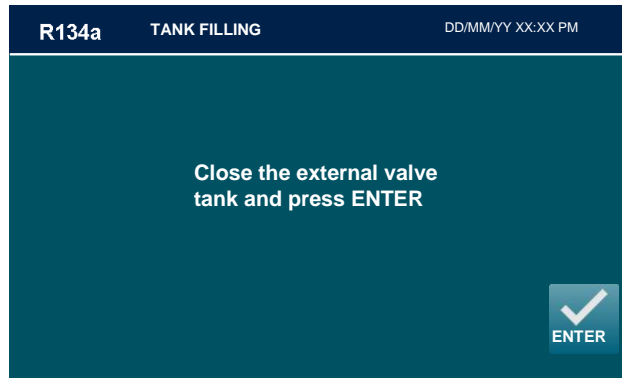


Procure a tank of appropriate refrigerant (R134a or R1234yf depending on machine model), connect and open LP coupler to the liquid side of the external tank and open the liquid valve, then Use the keypad to insert the amount of refrigerant, then press ENTER to continue.

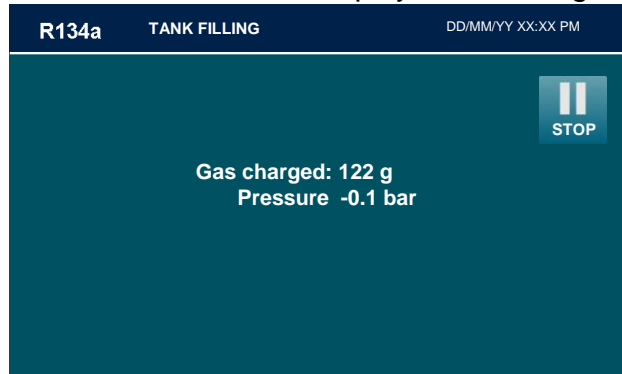
The TANK FILLING will start.



The machine will now fill the machine tank with the preset quantity ~ 500g. When the quantity minus 500 grams is reached, the machine will stop and display:



Close the liquid valve of the external tank and press ENTER, the machine will recover the residual refrigerant from the hoses, then will display the following screen:



Close and disconnect LP coupling from external tank and press ENTER.

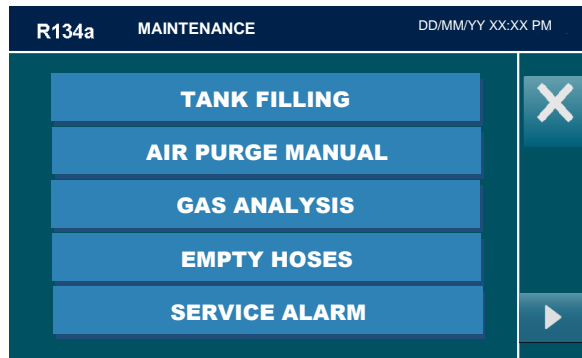


Tank filling procedure successfully completed. Switch the machine off.

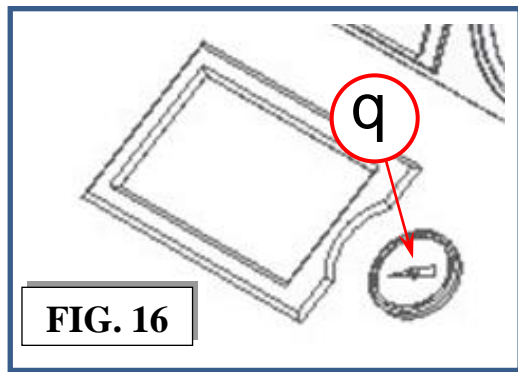
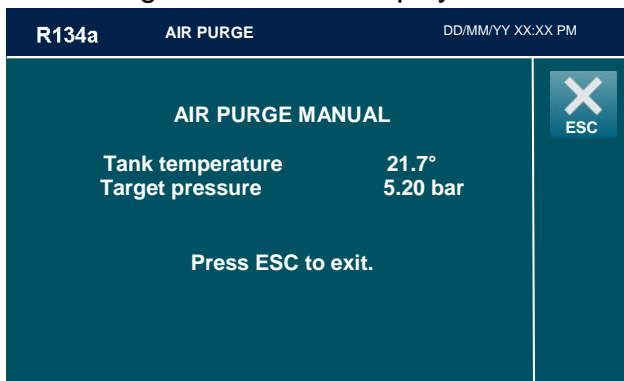
**NOTE:** if the external tank is not supplied with a liquid side coupling, upend it to recover liquid refrigerant.

# AIR PURGE MANUAL

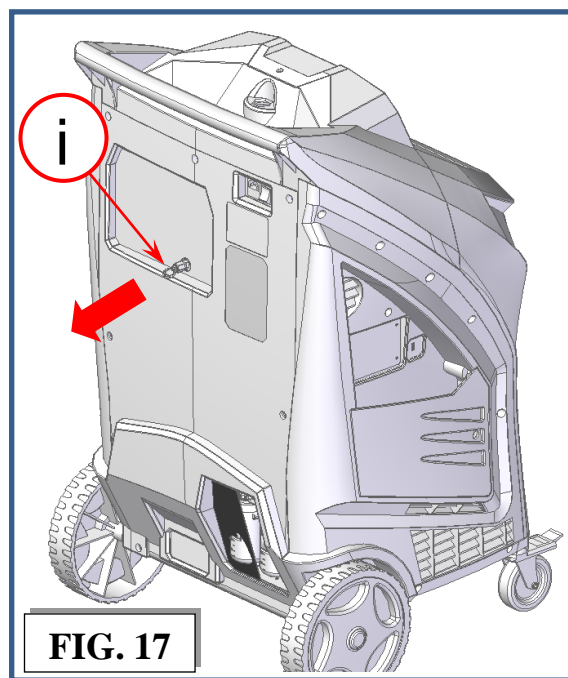
Before each service check the presence of air in the cylinder, select the MAINTENANCE MENU and press AIR PURGE MANUAL.



The following screen will be displayed:

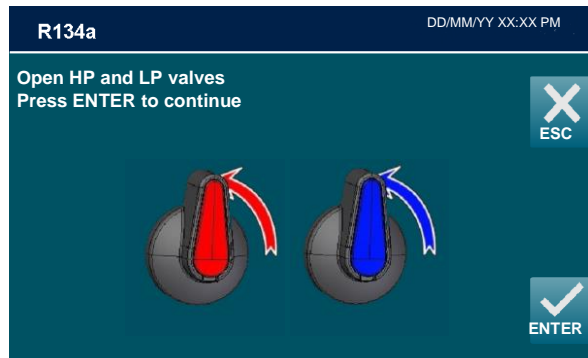
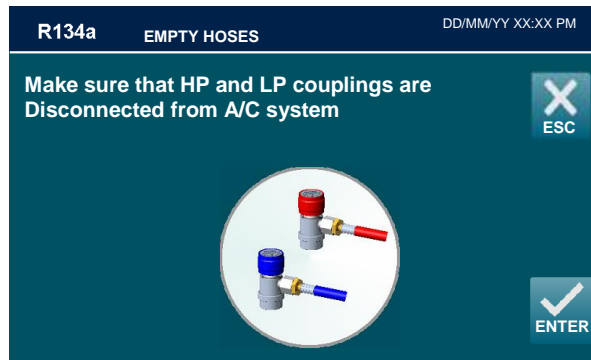


Read the temperature of the tank compare the pressure of the tank through the pressure gauge (ref q, Fig.16) with that on the display; if the tank pressure is higher than the one suggested by the machine, pull the safety valve ring (ref i, Fig.17) and bring the tank pressure back to the correct values:

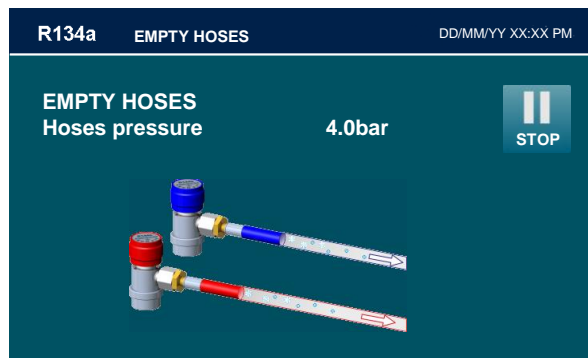


## EMPTYING HOSES

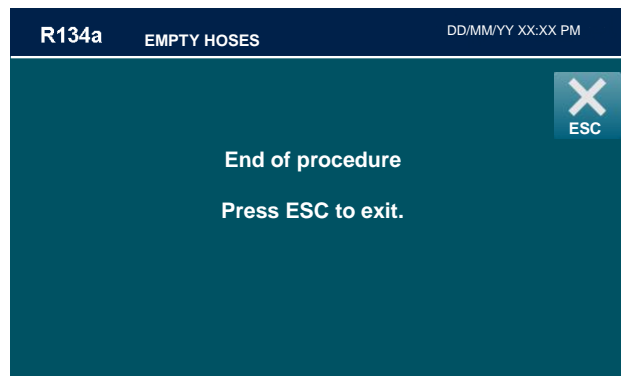
From MAINTENANCE, select EMPTYING HOSES, the following screen will be displayed:



Open manual valves and press ENTER.



The machine will recover all the refrigerant into the service hoses; then the machine will sound and alarm and the following screen will be displayed:



Press ESC to return to the MAINTENANCE MENU; EMPTYING HOSES is now successfully completed.

## CHANGE DRYER FILTER

Replace the filter whenever the machine gives the service alarm signals the presence of humidity in the circuit.

Before performing any operation, check that the replacement filter is the same type as these installed on the machine.

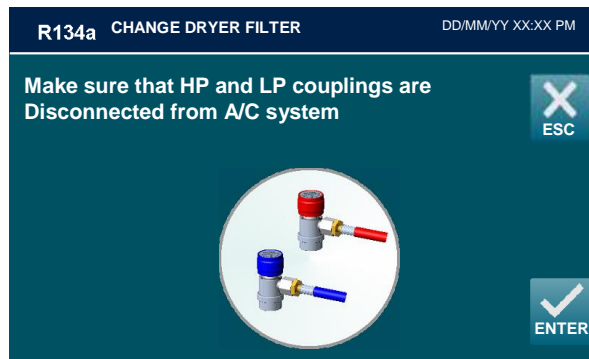
Then proceed as described below:

- 1) **Wear protective gloves and glasses**
- 2) Connect the machine to the electrical supply and it turn on
- 3) Note down the release code on the new filters.

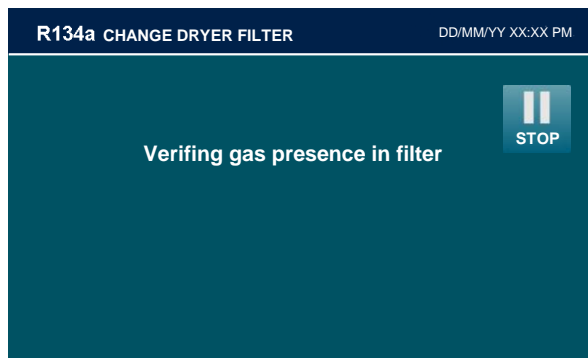
**IMPORTANT: Filter replacement must be performed as quickly as possible in order to avoid possible contamination by moisture in the ambient air.**

NOTE: If possible, check the seal on the couplings of the new filter, using an electronic leak tester.

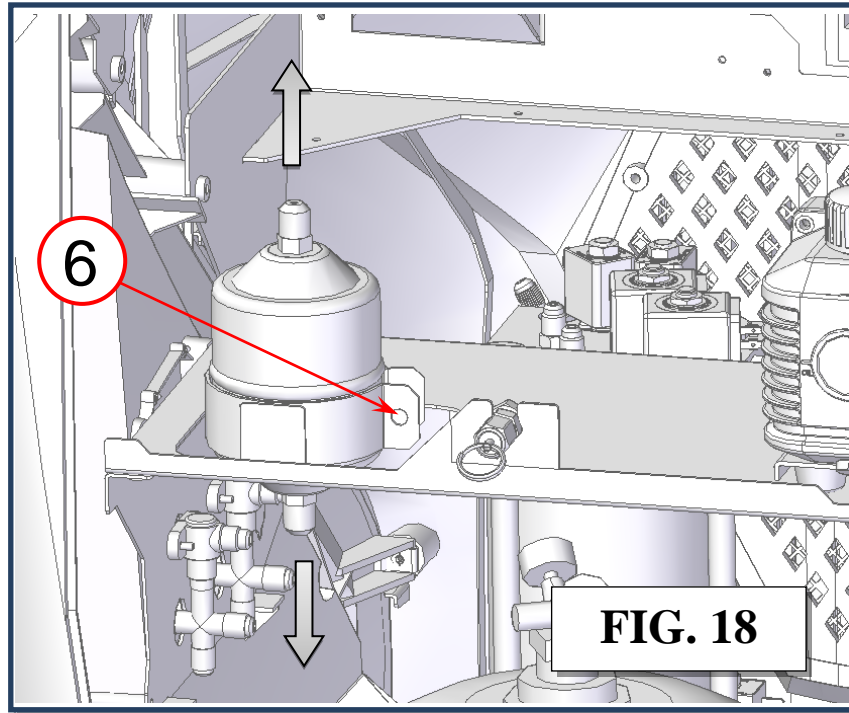
- 4) From MAINTENANCE, select SERVICE ALARM, the following warning message is visualized:



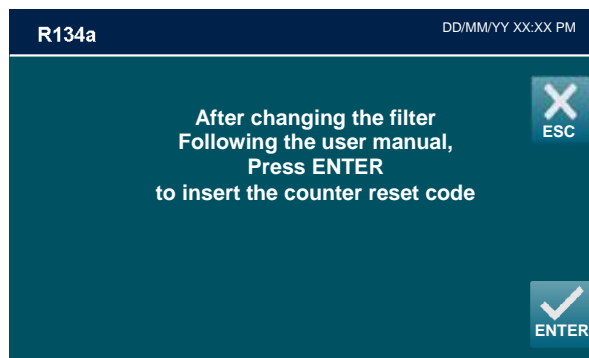
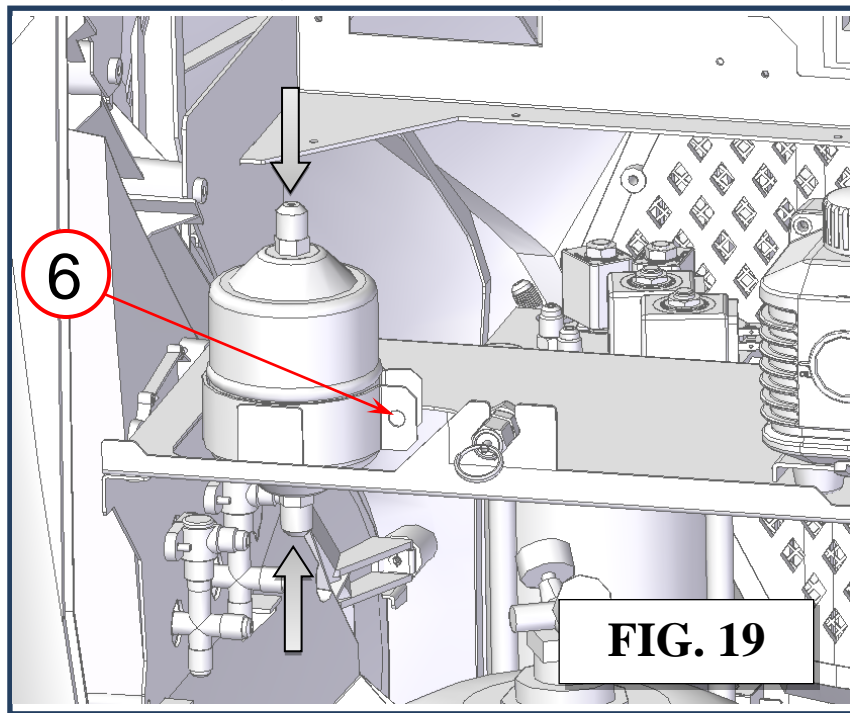
An accidental leakage of refrigerant may cause serious damage to skin and eyes, wear protective gloves and goggles. Make sure that HP and LP coupling are disconnected from A/C system or else and press ENTER, machine will check presence of refrigerant:



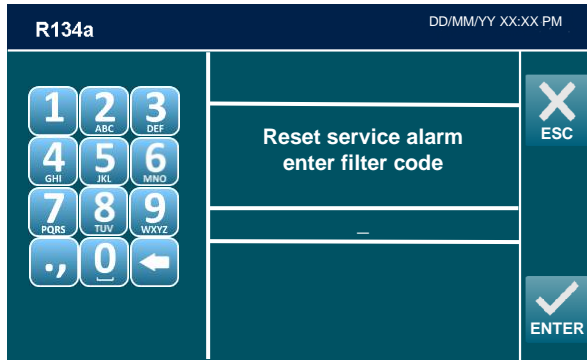
- 5) And if necessary will recover it
- 6) Remove the dryer filter, unscrewing the screw (ref 6, Fig.18) and the pipes



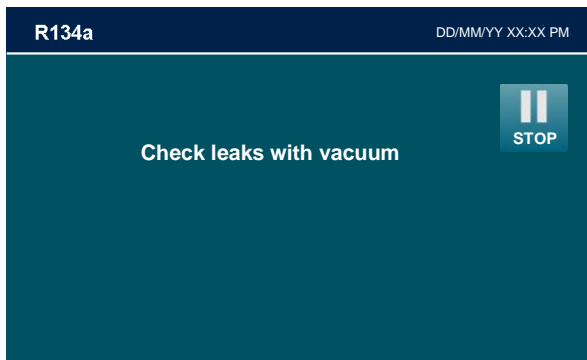
- 7) Install the new dryer filter, fixing the screw (ref 6 Fig.19) and the pipes



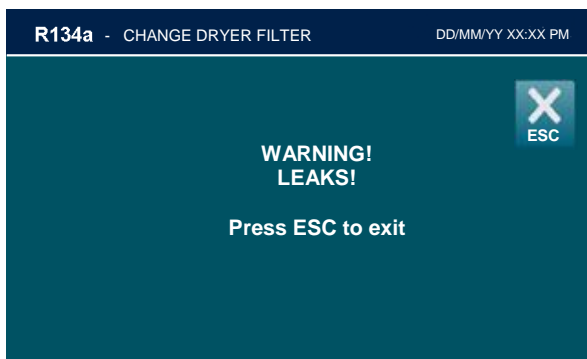
- 8) Type the filter code and press ENTER to delete the alarm. If the filter code is not available, call the Service Center:



9) Press ENTER to continue with vacuum check:

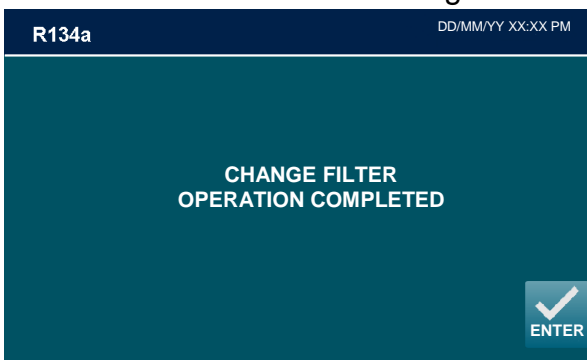


10) If leaks are detected the following screen will be displayed:

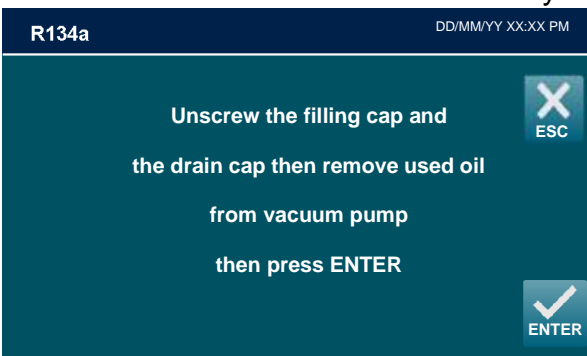


Check filter tightening and press ESC to restart the vacuum check.

11) After few minutes, if no leaks are detected the following screen will be displayed:



12) Press ENTER; DRYER FILTER CHANGE is now successfully completed.



## VACUUM PUMP

At the same time as the filter change the machine will ask to change the vacuum pump oil

Perform the operations listed below on a routine basis in order to ensure good operation of the vacuum pump:

M1) Oil top-up.

M2) Oil change.

When topping-up or replacing the pump oil, use only the oil recommended by the manufacturer. Contact your retailer for information concerning the correct type of oil.

### M.1) OIL TOP-UP

This operation must be performed when the level of the oil falls to less than half on the indicator (ref.3, Fig.20).

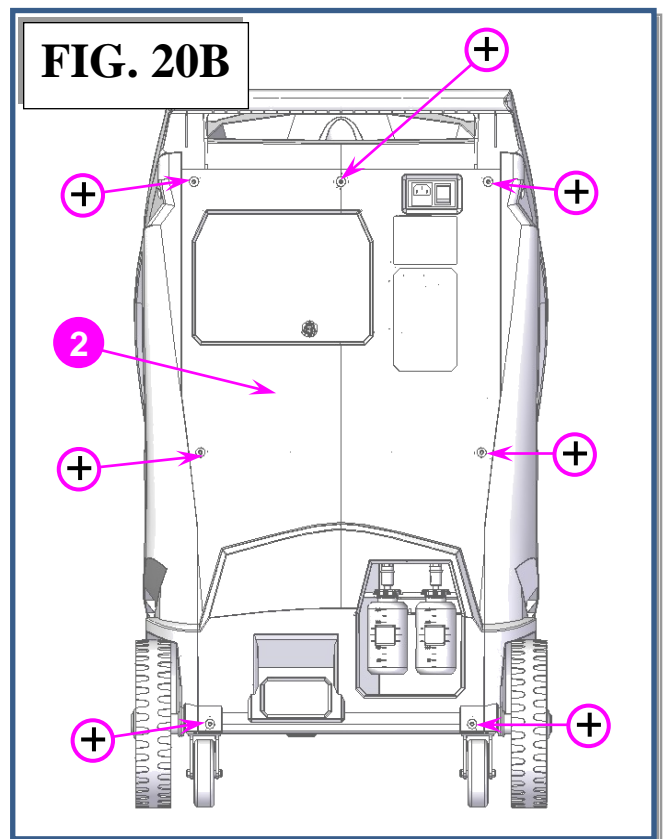
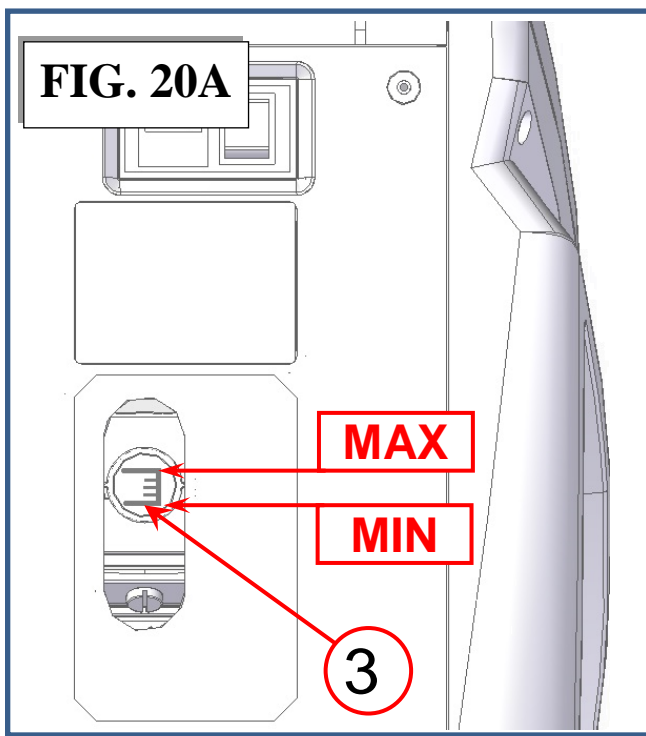
**NOTE:** in order to correctly check the oil level, run the pump for at least 1 minute (running a vacuum procedure in the hose for 1 minute) so that the oil fluidifies.

Check the oil level when the pump stops.

To refill the oil, perform the steps listed below in the order given.

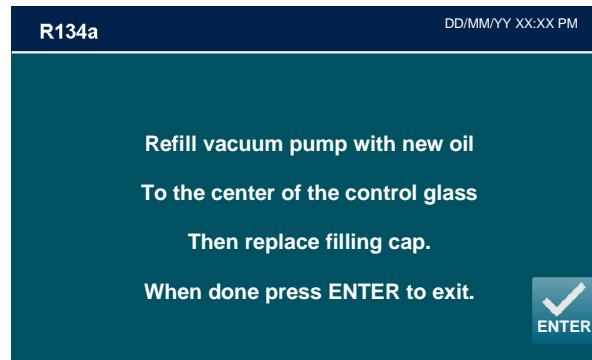
Disconnect the *machine* from the mains supply. Remove the rear plastic cover (ref 2, Fig.20B)

Locate the filling cap (ref 1, Fig.20A) and screw it completely off.

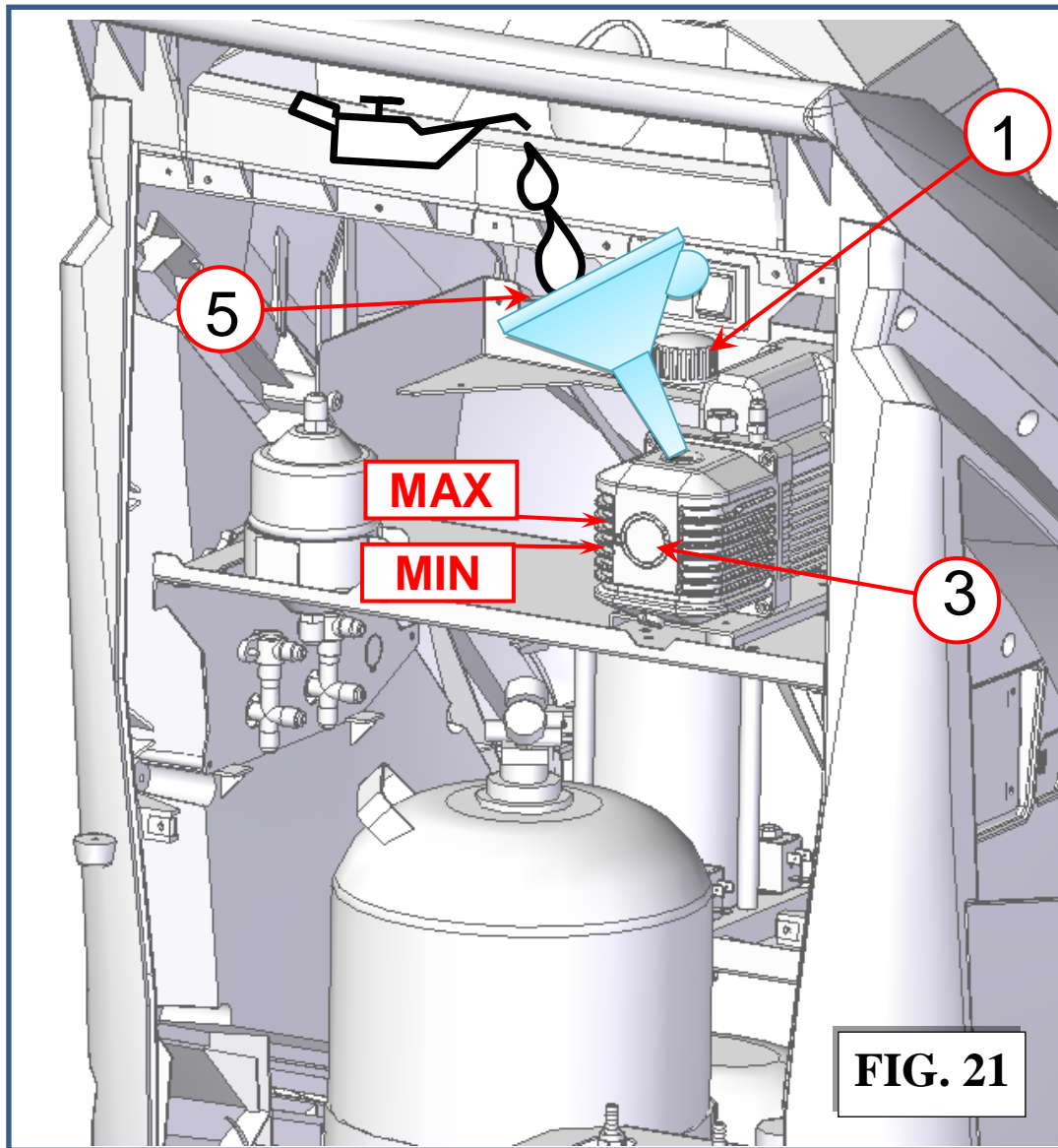




The following screen is displayed:



The oil must be added through the hole in which the oil cap was lodged by using a proper funnel (ref 5, Fig.21).



Add oil a little at a time, waiting for the level to rise before each successive addition, until the oil level is about  $\frac{1}{2}$  cm above the red mark on the indicator (ref 3, Fig.21).

Replace the filling cap (ref 1, Fig.21) and tighten down.

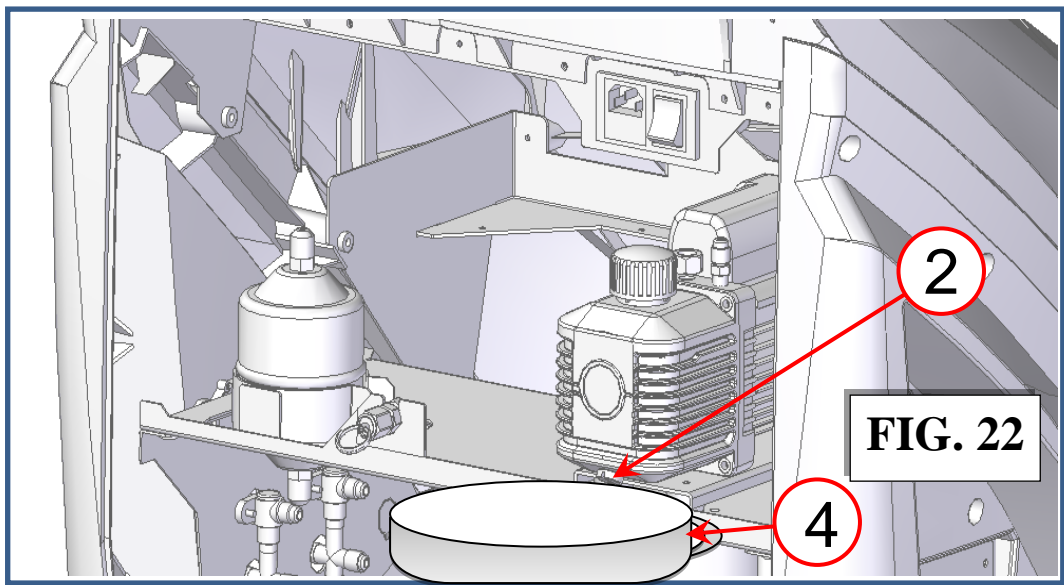
## M.2) OIL CHANGE

The vacuum pump oil must be replaced every 20 hours of functioning and in any case every time the refrigerant filters are replaced.

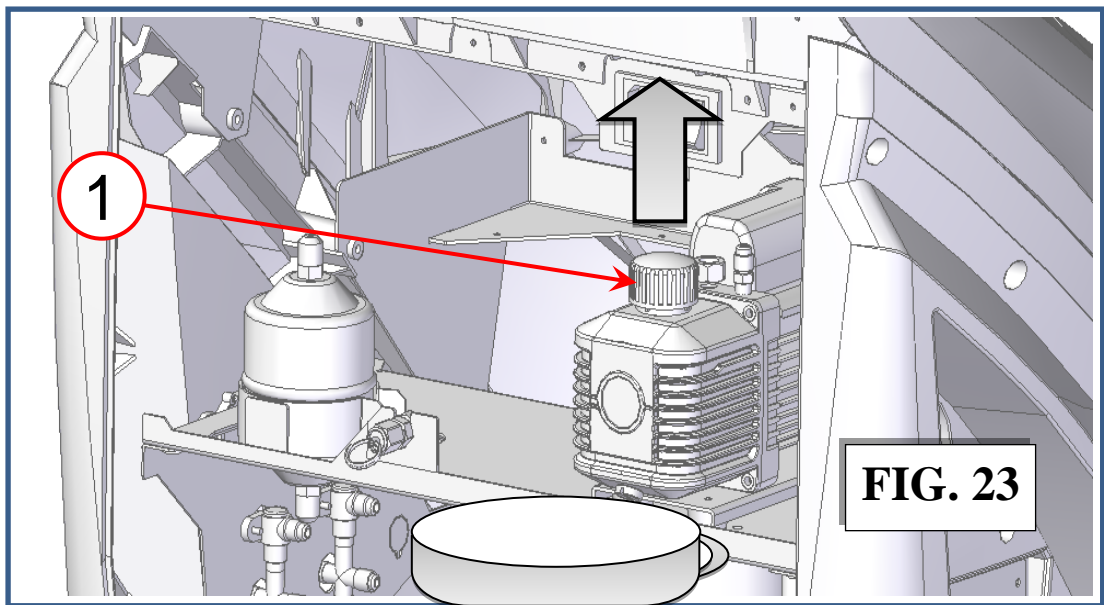
**NOTE:** alarm message is visualized, to remove alarm message refer to VACUUM PUMP OIL CHANGE paragraph.

The oil must also be replaced whenever it changes color due to absorption of humidity. Before beginning the oil change procedure, procure a container of at least 500 cc capacity in which to collect the used oil. The pump contains about **240 ml of oil**. Use only the oils recommended by the manufacturer (consult your retailer); the use of a non-recommended oil may impair the proper functioning of the pump and void the warranty.

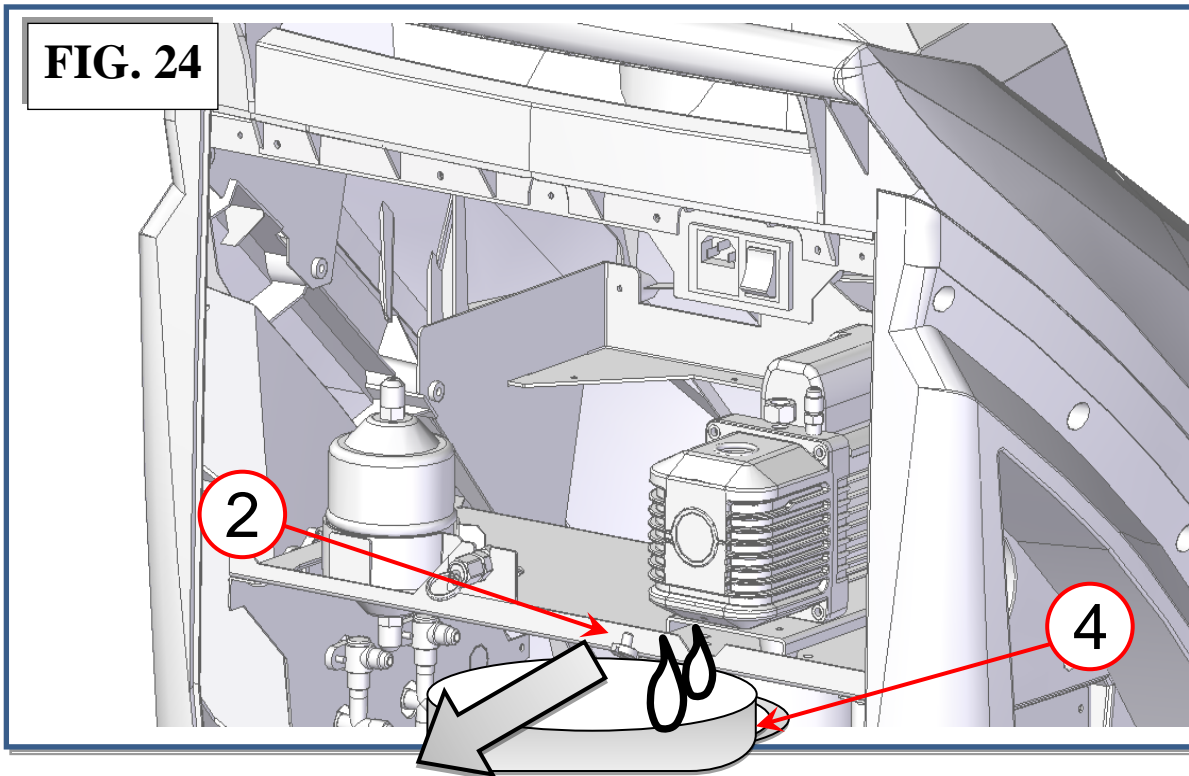
- 1) Disconnect the machine from the mains supply.
- 2) Place a container (ref 4 Fig.22). under the drain cap (ref 2, Fig.22).



- 3) Unscrew the filling cap (ref 1, Fig.23).

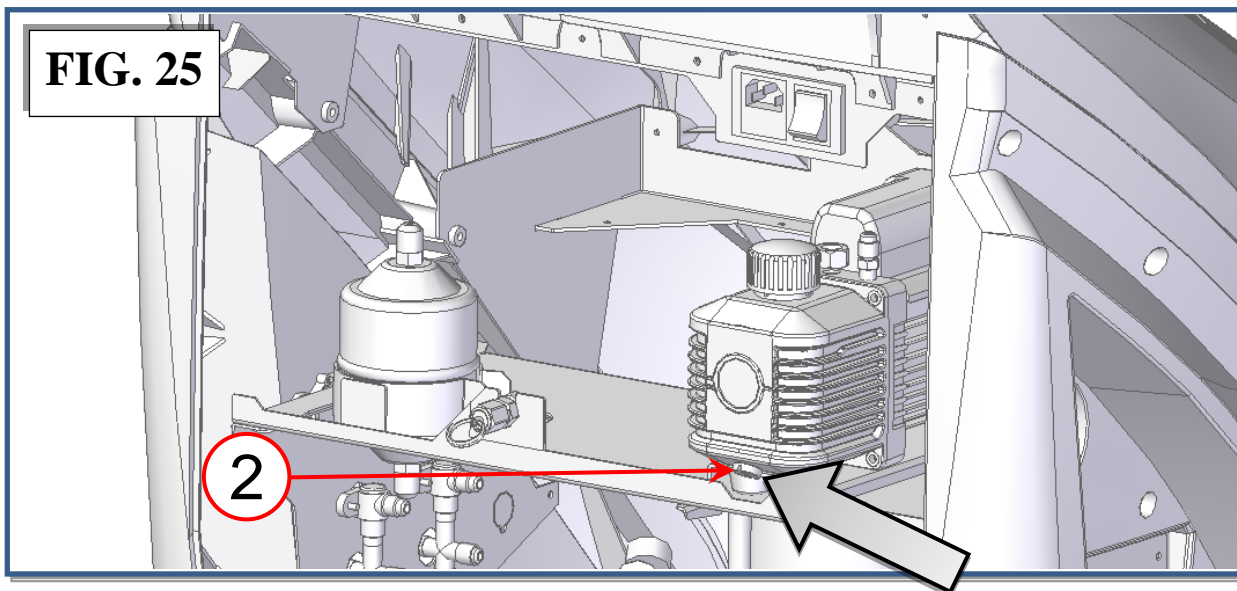


- 4) Unscrew the drain cap (ref 2, Fig.24).

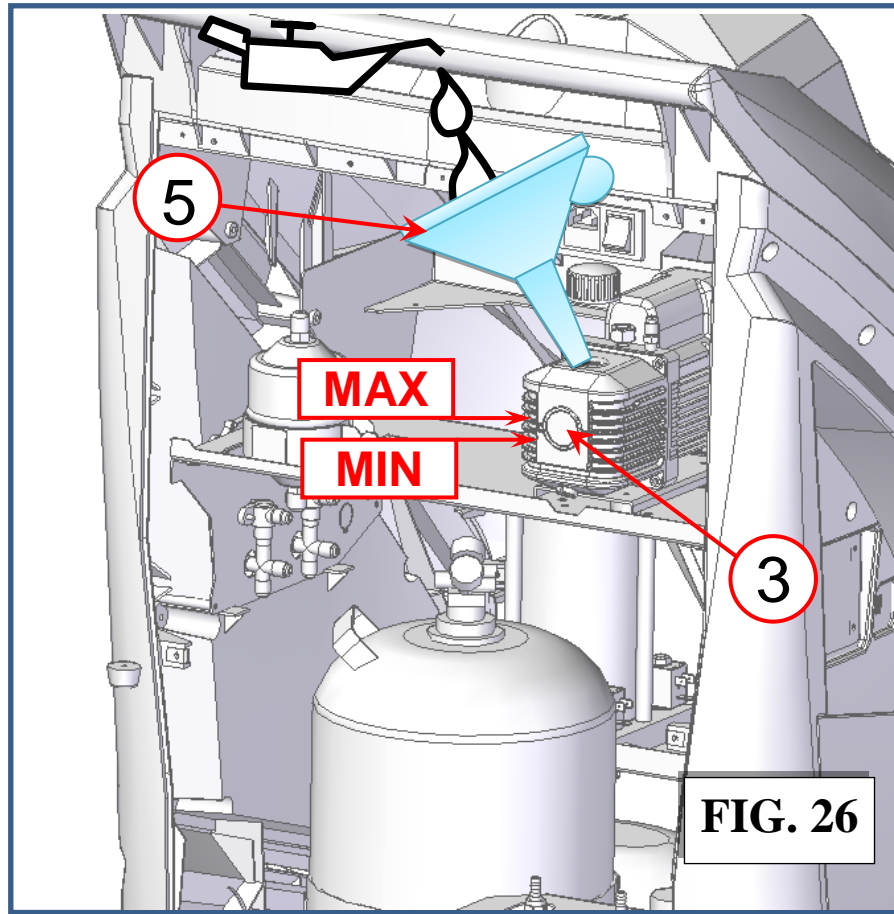


Allow all the oil to run out into a disposal container (ref 4 Fig.24) (with height < 10 cm).

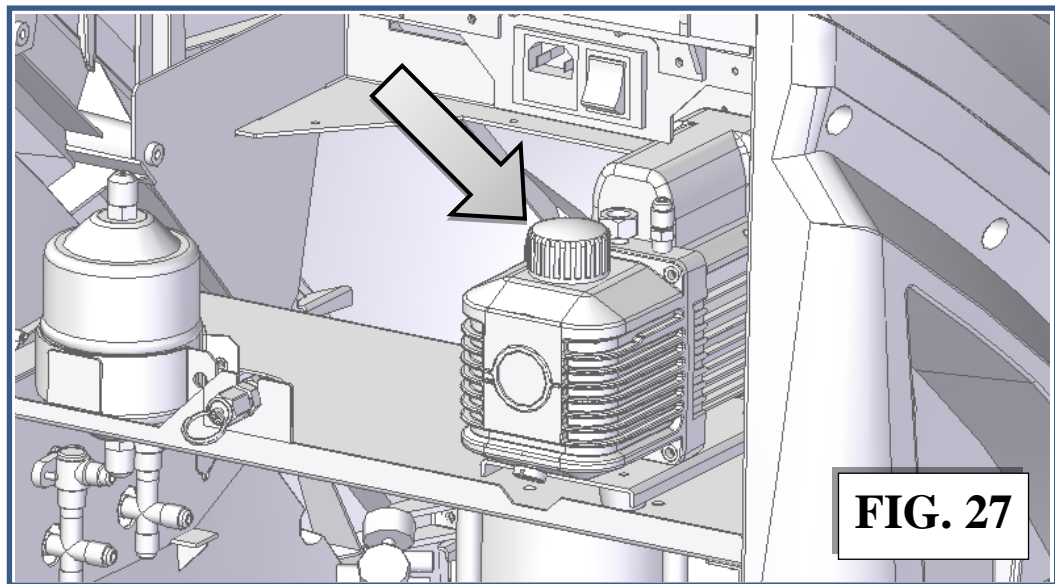
- 5) Close the drain cap (ref 2, Fig.25).




- 6) Pour in new oil through the filling hole, using a proper funnel (ref 5, Fig.26), until the level rises to the midpoint on the indicator (ref 3, Fig.26).

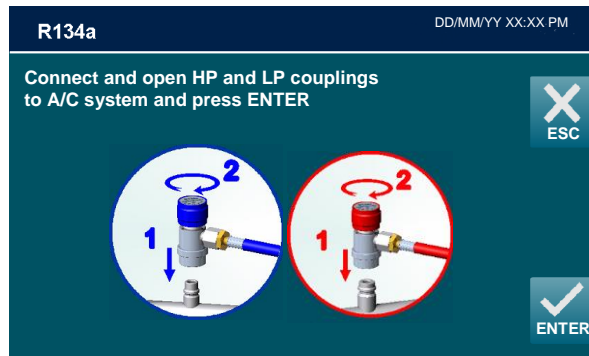


7) Replace the filling cap (ref 1, Fig.27) and tighten down.

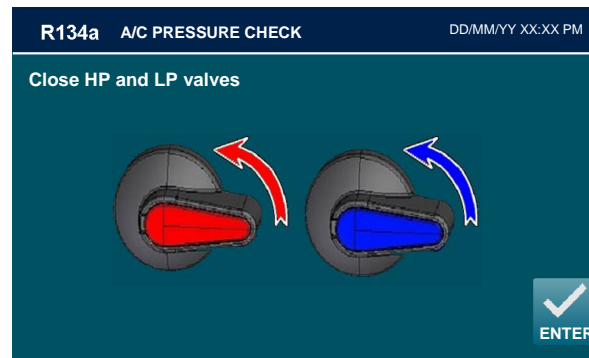


## A/C PRESSURES CHECK

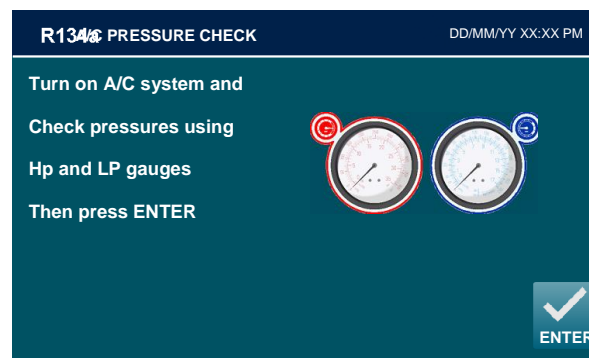
From MAINTENANCE scroll to page 2 with the arrow  and select A/C PRESSURES CHECK, the following screen will be displayed:



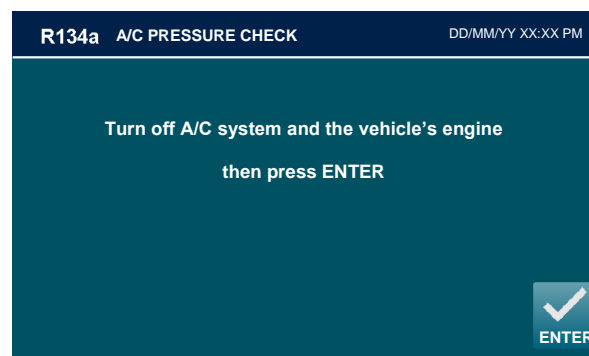
Connect and open the coupling connected to the A/C system, then press ENTER, press ESC to return back; the following screen is displayed:



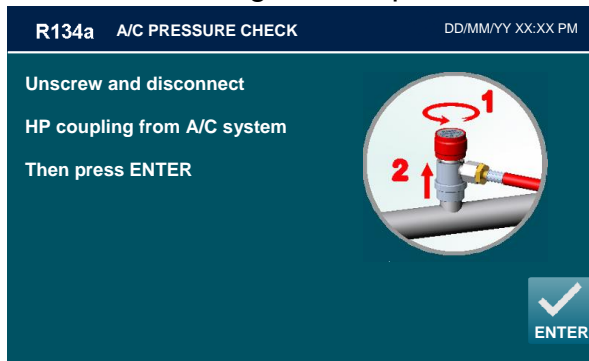
Close HP and LP valves. Press ENTER.



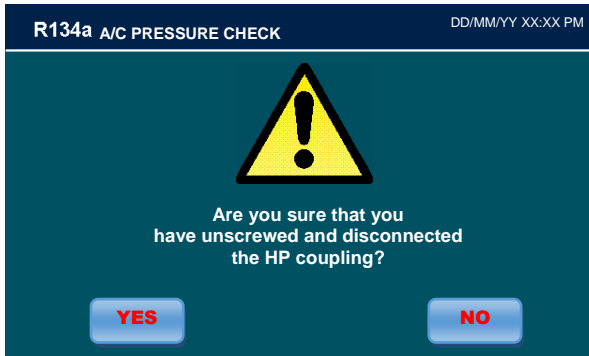
Turn on A/C system and check pressure using HP and LP gauges, then press ENTER:



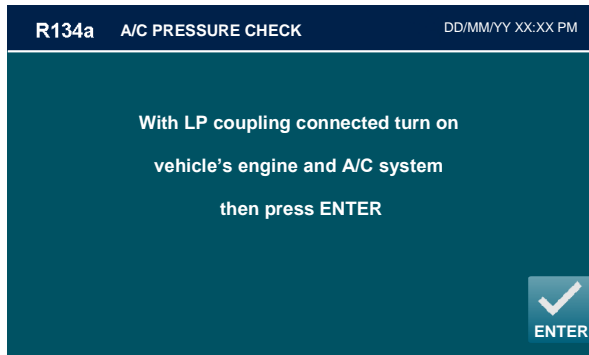
Turn off A/C system and the vehicle's engine, then press ENTER:



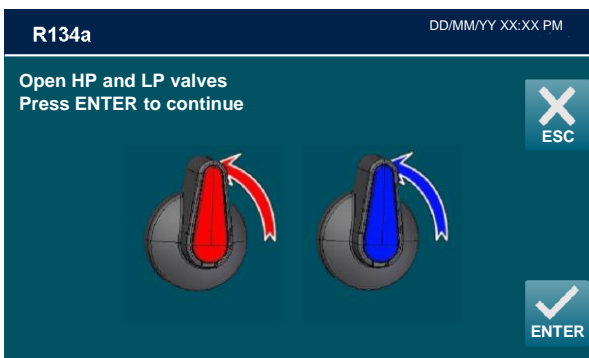
Unscrew and disconnect HP coupling, then press ENTER:



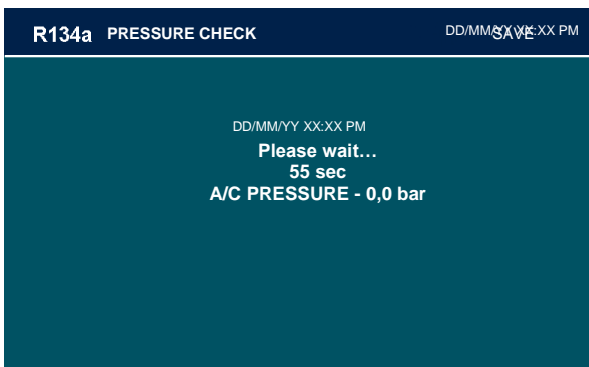
Press YES to confirm:



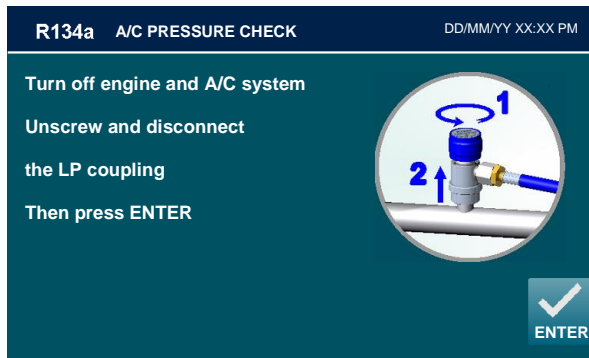
With LP coupling connected turn on the vehicle's engine and A/C system, then press ENTER:



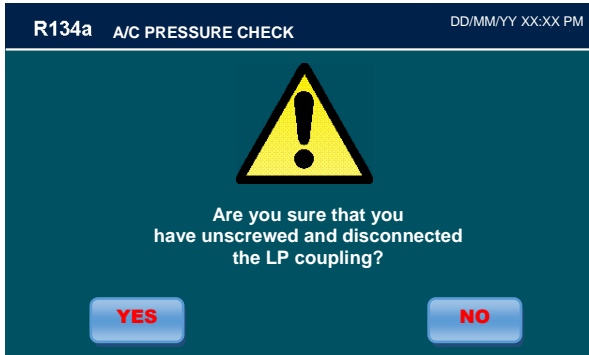
Open HP and LP valves. Press ENTER to continue:



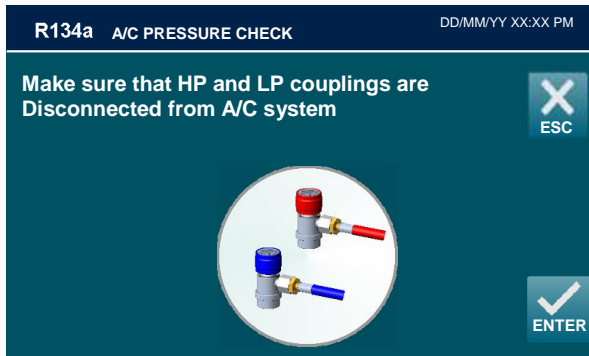
The vehicle's A/C system will recover the refrigerant from the service hoses, then:



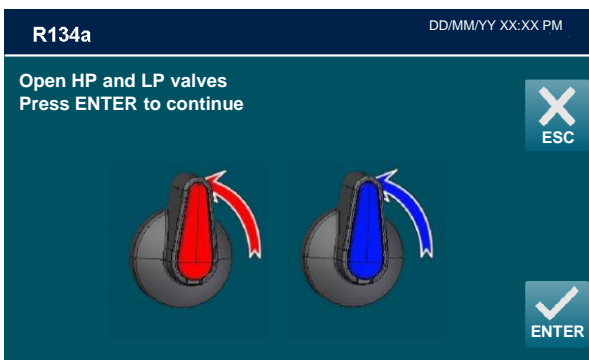
Turn off engine and A/C system, unscrew LP coupling without disconnect it, then press ENTER:



Press YES to confirm:



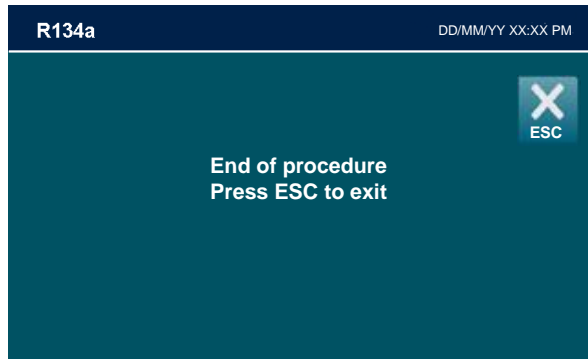
Make sure that HP and LP couplings are disconnected from A/C system:



Open HP and LP valves. Press ENTER to continue:




The machine will recover the residual refrigerant into the service hoses, then the following screen will be displayed:

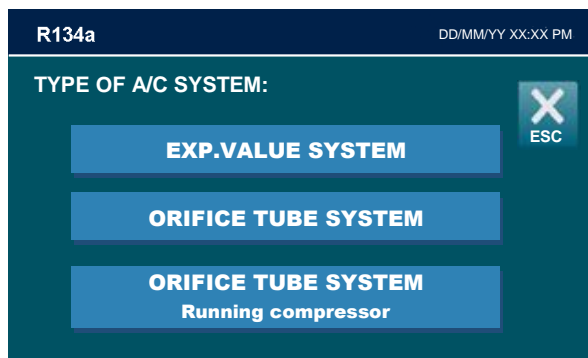


Disconnect coupling from A/C system, press ESC to return to the MAINTENANCE MENU; A/C PRESSURES CHECK is now successfully completed.

## STATIC DIAGNOSIS

**NOTE:** during STATIC DIAGNOSIS, it is not necessary connect the service hoses to the A/C system

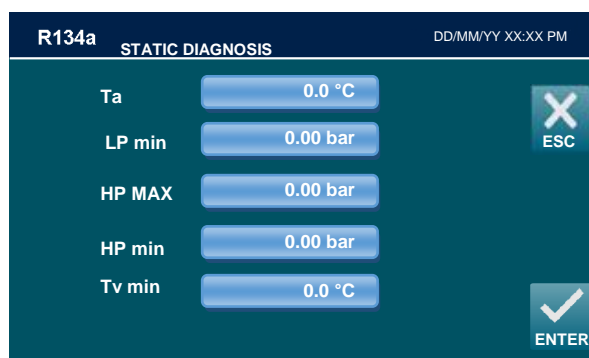
From MAINTENANCE scroll to page 2 with the arrow  and select STATIC DIAGNOSIS the following screen will be displayed:



select the A/C system type

**NOTE:** Incorrect selection of A/C system type may falsify diagnostic results.

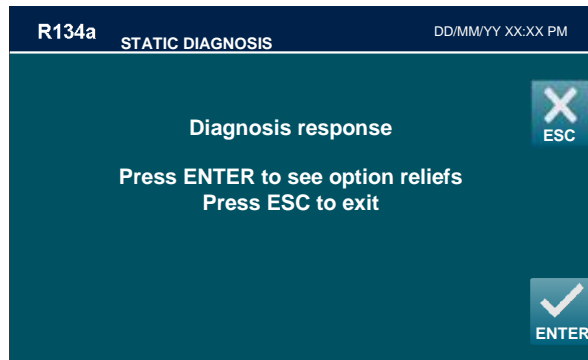
The following screen will be displayed:



Type in, in order, the minimum value of low pressure, the maximum and minimum value of high pressure of the A/C system, and the temperature of the air at the outlet from the vents in the passenger compartment (use the thermometer supplied with the machine to measure).



Then press ENTER to confirm, the following screen will be displayed:




Press ENTER to print the diagnosis report: should the diagnosis results not be positive, the printout will list from one to three possible system problems. When checking, always start with the first DIAGNOSIS shown and check each in the order given, applying the REMEDIES listed for each DIAGNOSIS.

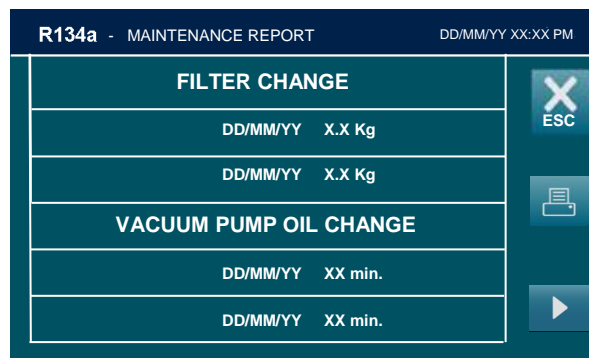
Retest the A/C system with the machine after the first DIAGNOSIS has been checked out and/or repaired, in order to determine whether or not the repair has solved the system problem. Retest after each DIAGNOSIS has been verified and/or the trouble repaired.

**OPTIMUM CONDITIONS FOR A/C SYSTEM DIAGNOSTICS:** Wind speed ca. 0 km/h. A/C fan set to second speed. A/C temperature control set to maximum cold. External (ambient) temperature from 21°C to 38°C. Engine at 1500 RPM for two minutes. Do not expose the vehicle to direct sunlight during diagnostic testing.

## MAINTENANCE REPORT


The machine keeps track of the maintenance operations done.

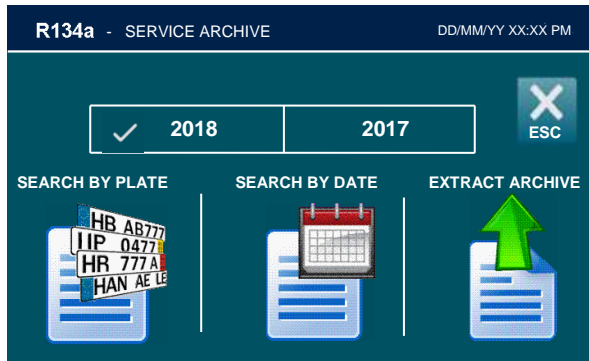
From MAINTENANCE scroll to page 2 with the arrow  and select MAINTENANCE REPORT the following screen will be displayed:



## SERVICES ARCHIVE

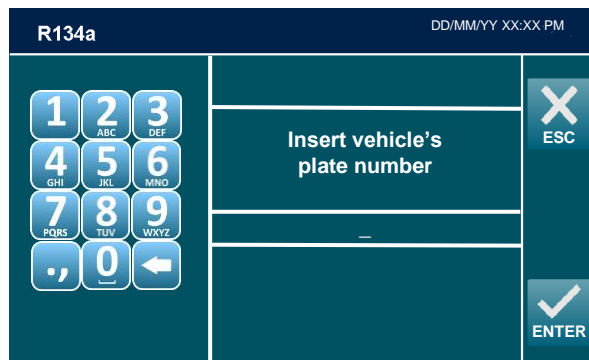
The machine keeps track of the operations done on refrigerant fluid: recovery, system refilling, inner tank filling. For any operation, a record is made with date, time, type of operation, quantities involved, operator nr., inner tank refrigerant fluid availability.

From MAINTENANCE scroll to page 2 with the arrow  and select STATIC DIAGNOSIS the following screen will be displayed:

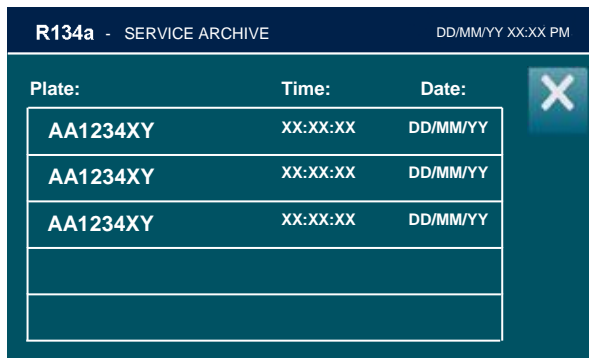


### SEARCH BY PLATE

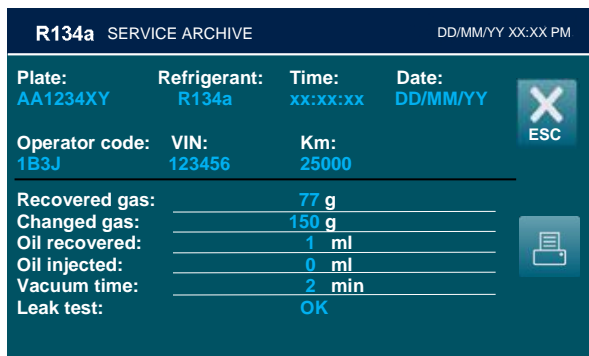
Selecting SEARCH BY PLATE, the following screen will be displayed:




Use the keypad to insert plate number to search, then press ENTER:



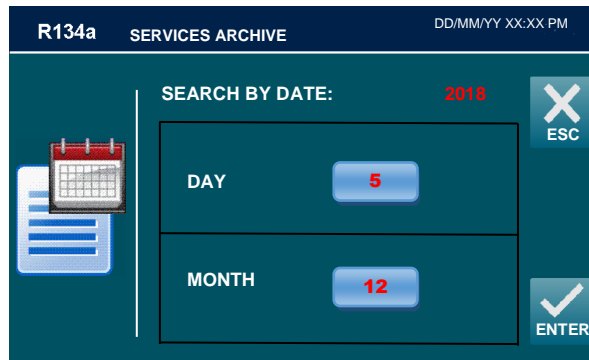
A list will be displayed, select service for detailed info:



Press  to print the report of the service, or press ESC to return to previous menu.

## SEARCH BY DATE

Selecting SEARCH BY DATE, the following screen will be displayed:



Insert date to search, then press ENTER:

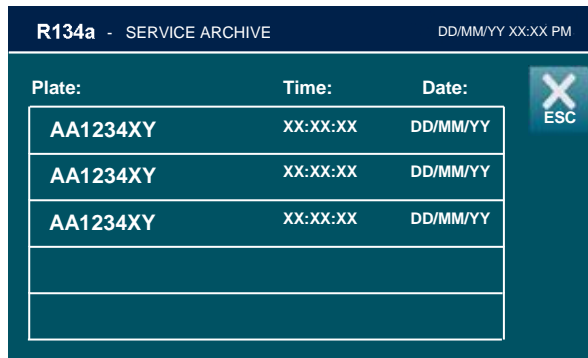


Plate:	Time:	Date:
AA1234XY	XX:XX:XX	DD/MM/YY
AA1234XY	XX:XX:XX	DD/MM/YY
AA1234XY	XX:XX:XX	DD/MM/YY

A list will be displayed, select service for detailed info:

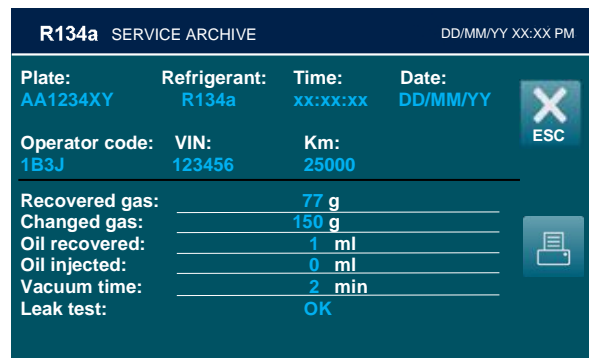

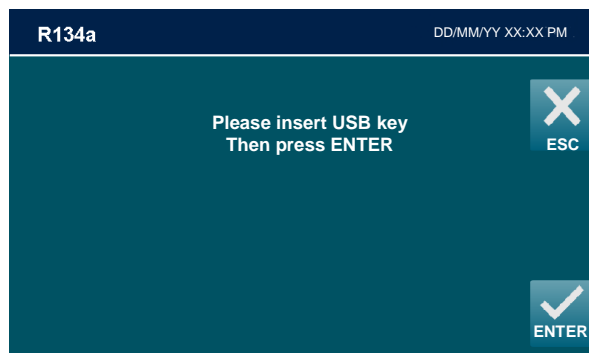


Plate:	Refrigerant:	Time:	Date:
AA1234XY	R134a	XX:XX:XX	DD/MM/YY
Operator code:	VIN:	Km:	
1B3J	123456	25000	
Recovered gas:		77 g	
Changed gas:		150 g	
Oil recovered:		1 ml	
Oil injected:		0 ml	
Vacuum time:		2 min	
Leak test:		OK	

Press  to print the report of the service, or press ESC to return to previous menu.

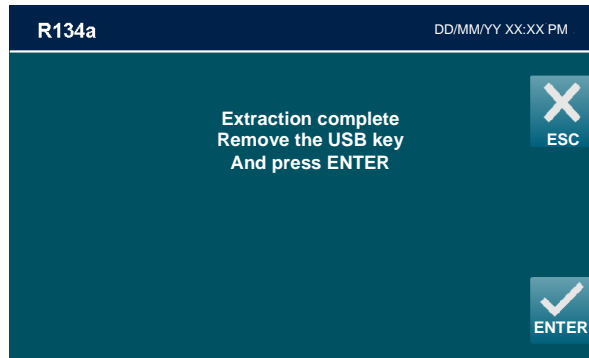
## EXTRACT ARCHIVE

Selecting EXTRACT ARCHIVE, the following screen will be displayed:



Insert the storage device (FAT32, 256mb min.) in the USB port and press ENTER, to save to copy a .CSV file with all the operations into the Pendrive.


The following screen will be displayed for few seconds:

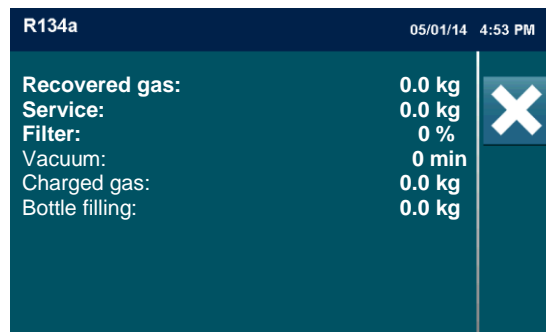


Extraction is now completed, the machine will return to the previous menu.

## COUNTERS

This is used to check total COUNTERS of: recovered gas, service alarm meter, total vacuum minutes, injected gas, gas recovered into the tank with the tank refilling function.

From MAINTENANCE scroll to page 2 with the arrow  and select COUNTERS the following screen will be displayed:



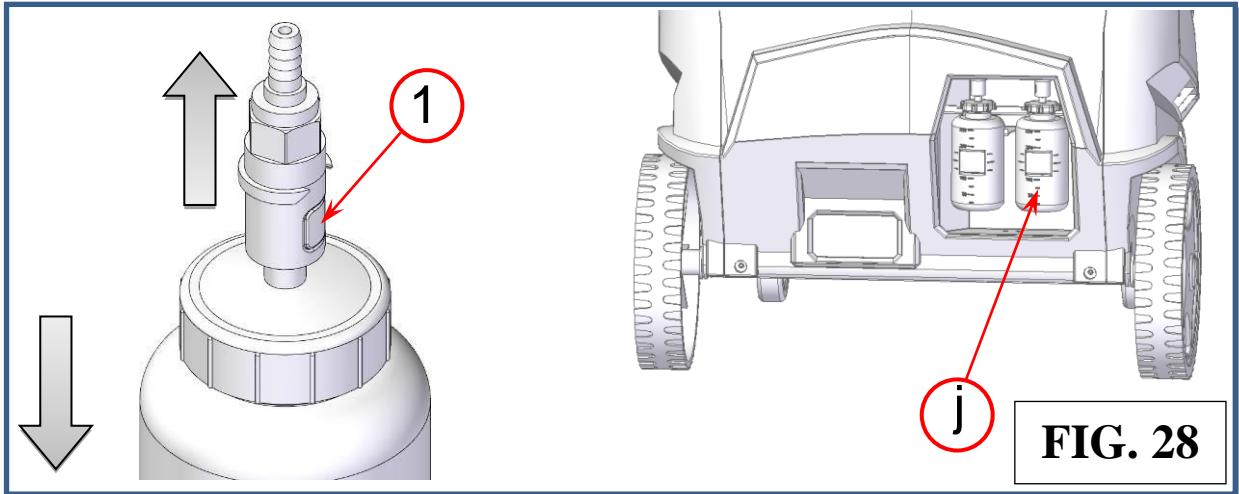
This screen displays the total values for: gas recovered, service alarm COUNTERS, total vacuum time (minutes), gas injected, gas recovered in the internal tank

## FILLING THE RECHARGEABLE NEW OIL CONTAINER

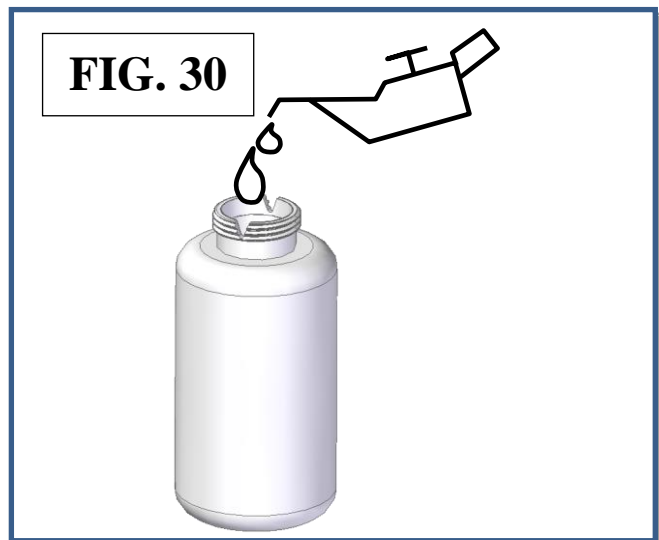
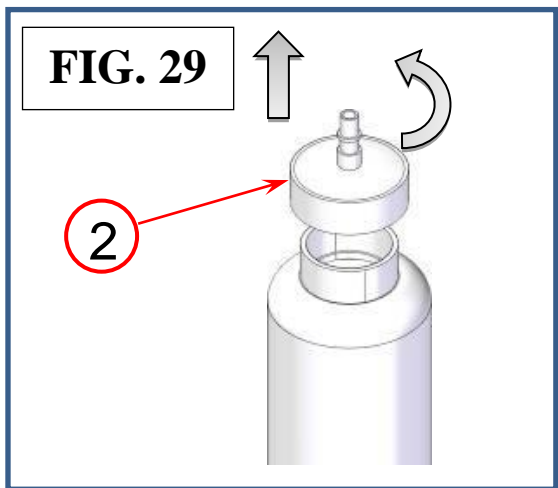
Types of oil: use only oils recommended by the manufacturer or by the car manufacturers. Always refer to the information provided by the A/C system manufacturer. Never use waste oil.

Procedure:

1. Press quick connection button (ref 1, Fig.28) to disconnect the oil container OIL container (ref j, Fig.28);
2. Remove the container from its lodging



3. Hold the container and unscrew the cap (ref 2, Fig.29). Fill the container (Fig.30) with the correct quantity (about 250-260ml) of oil for compressors, of suitable type and grade.



**NOTE:** in order to reduce humidity and air contamination of new oil, the collapsible container has to be filled almost to the brim.

4. Screw the cap (ref 2, Fig.29) back into the container.
5. Replace the container and hook it up to the quick connection taking care not to exert pressure on the scale in order not to damage it.

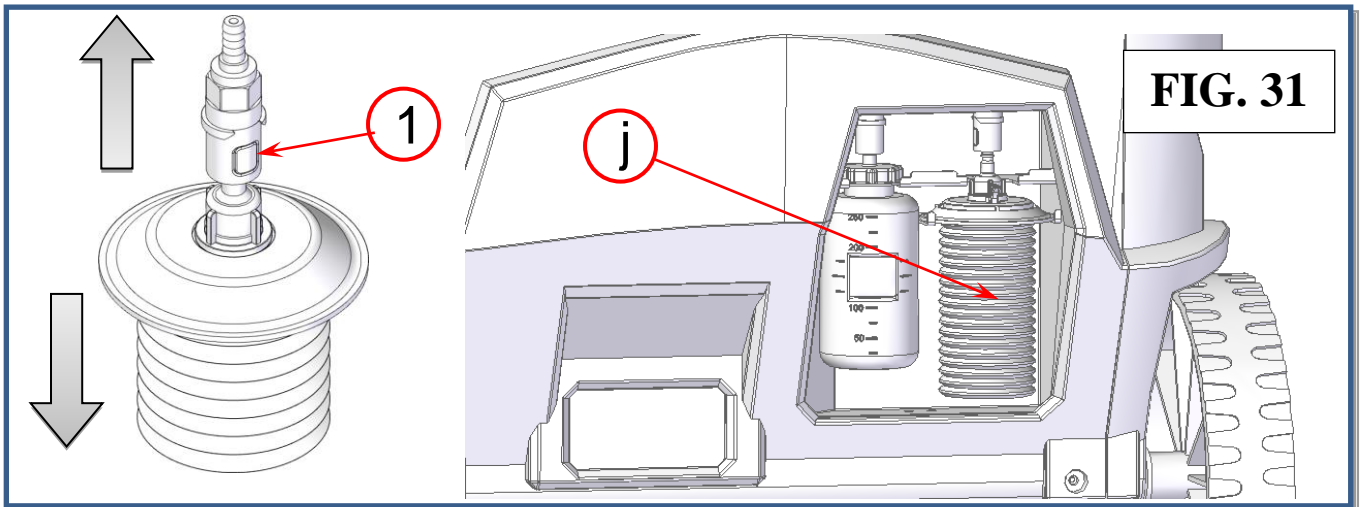
## REPLACE THE NEW OIL CARTRIDGE

When the level of the new oil drops by a few ml it is best to replace the collapsible cartridge in order to have a sufficient reserve.

Types of oil: use only oil cartridges recommended by the manufacturer. Always refer to the information provided by the A/C system manufacturer.

Procedure:

1. Press quick connection button (ref 1, Fig.31) to disconnect the oil cartridge OIL cartridge (ref j, Fig.31);
2. Remove the used cartridge container from its lodging



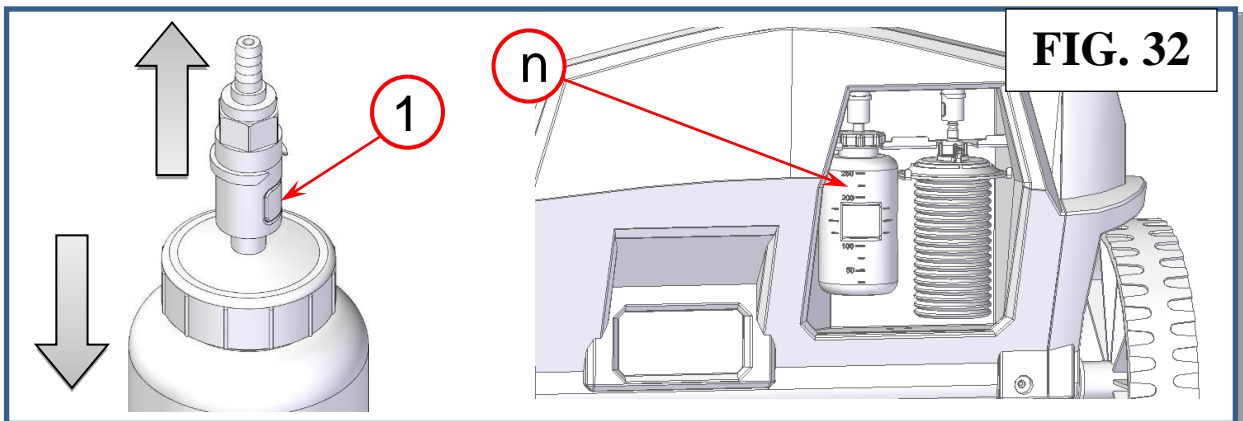
3. insert the male fitting of new oil cartridge into the quick connection and replace the cartridge in its lodging.

**NOTE:** Replace the cartridge taking care not to exert pressure on the scale in order not to damage it.

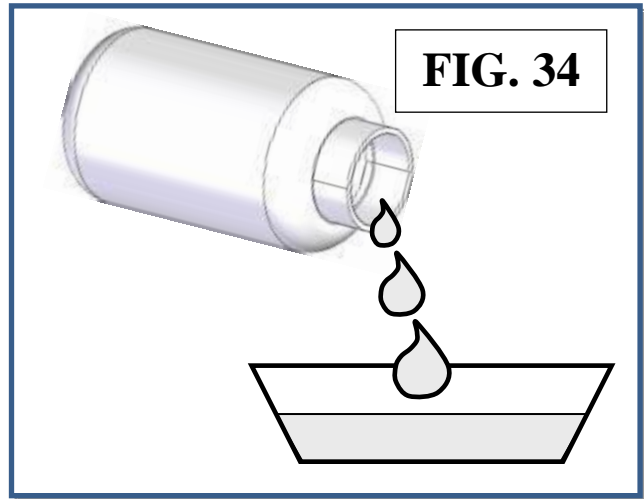
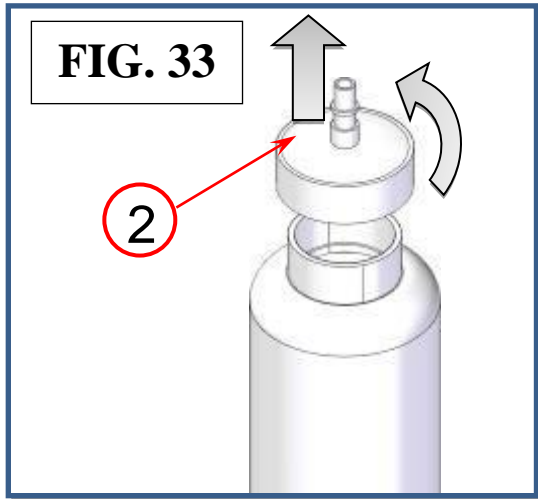
## EMPTYING THE USED OIL CONTAINER

Procedure:

1. Press quick connection button (ref 1, Fig.32) to disconnect the used oil container
2. Lift the used oil container out of its lodging (ref n, Fig.32) without exerting pressure on the scale.



3. Unscrew the cap (ref 2, Fig.33) while holding the container; empty the used oil into a suitable container for used oils (Fig.34).



4. Screw the cap back into the container.
5. Replace the container and hook it up to the quick connection taking care not to exert pressure on the scale in order not to damage it.

**NOTE:** In order to avoid damage to the oil scale, never exert pressure on it either from above or from below.

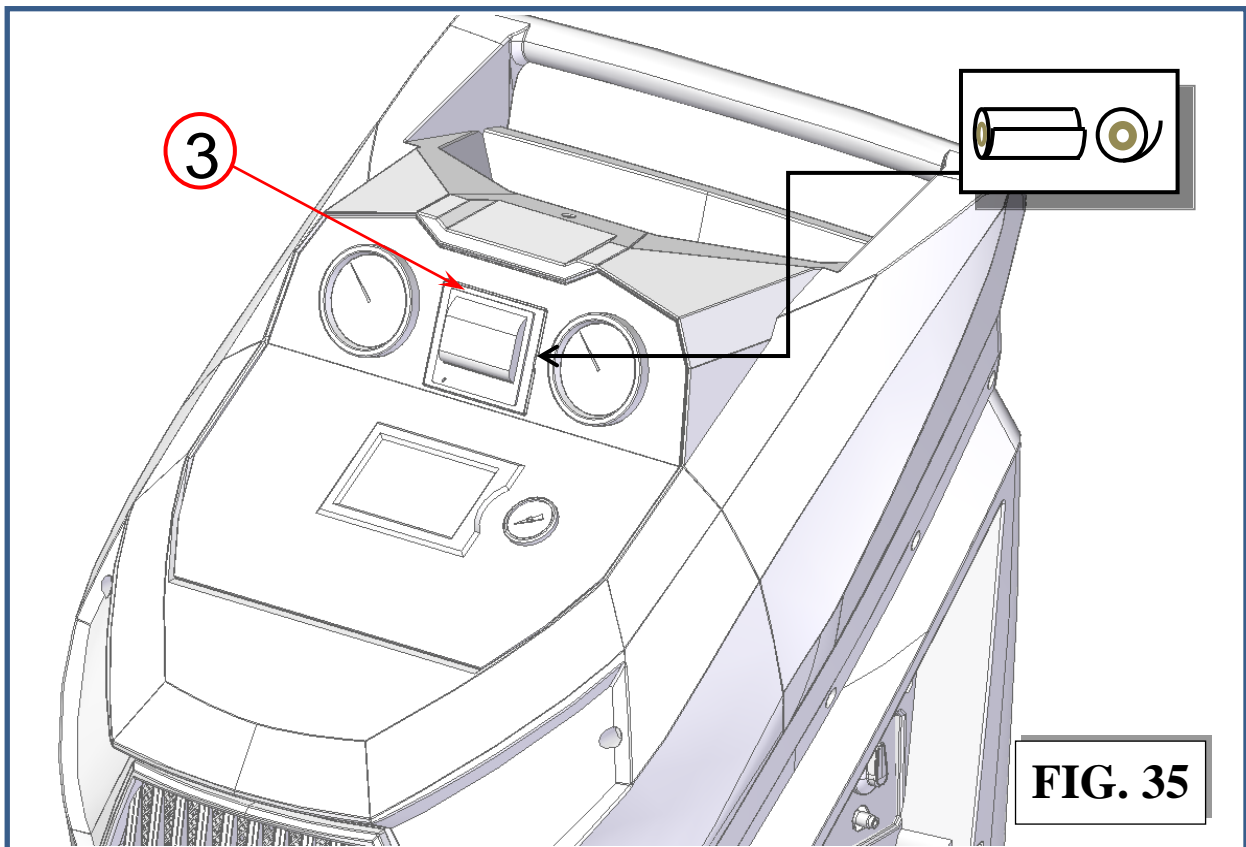
## REPLACING THE PRINTER PAPER

Open the print cover (ref 3, Fig.35), and replace the paper roll with a new one

Use only heat-sensitive paper of the type described below.

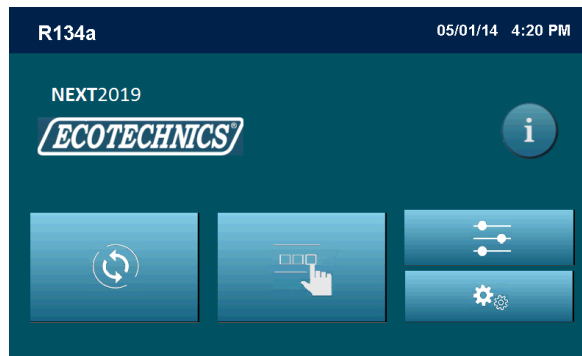
Paper width: 58 mm

Maximum paper roll diameter: 40mm

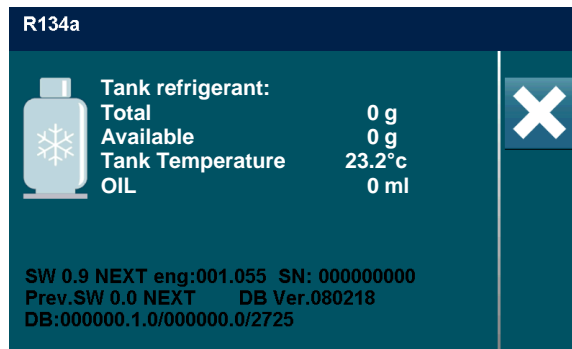


## DATA


This menu shows all data read by the machine. From the MAIN MENU:



Press “i” key , the following screen will be displayed:



- Tank refrigerant:
  - Total: total amount of refrigerant in the storage tank
  - Available: quantity of refrigerant available in the storage tank.
- Tank temperature: refrigerant storage tank temperature
- OIL: quantity of OIL in the OIL containers
- SW V.: Software version

Press  to return to MAIN MENU.



# CODES SUMMARY

OPTION code:

43210791